



Dell™ Latitude™ CS/CSx Portable Computers User's Guide

[Preface](#)

[Introduction](#)

[Setup and Operation](#)

[Powering Your Computer](#)

[Traveling With Your Computer](#)

[Drivers](#)

[Customizing Your Computer](#)

[Removing and Replacing Parts](#)

[Troubleshooting Your Computer](#)

[Technical Specifications](#)

[Getting Help](#)

**Information in this document is subject to change without notice.
© 1999 Dell Computer Corporation. All rights reserved.**

Reproduction in any manner whatsoever without the written permission of Dell Computer Corporation is strictly forbidden.

Trademarks used in this text: *Dell*, *Latitude*, *OptiPlex*, *Dimension*, *Inspiron*, *ExpressCharge*, the *DELL* logo, and *DellWare* are trademarks of Dell Computer Corporation; *Microsoft*, *Windows*, *Windows NT*, and *MS-DOS* are registered trademarks of Microsoft Corporation; *Intel* and *Pentium* are registered trademarks of Intel Corporation.

Other trademarks and trade names may be used in this document to refer to either the entities claiming the marks and names or their products. Dell Computer Corporation disclaims any proprietary interest in trademarks and trade names other than its own.

*Initial release: 25 Jun 1999
Last revised: 04 Nov 1999*

AC Adapter: Dell™ Latitude™ CS/CSx Portable Computers User's Guide

- [Using the AC Adapter](#)
 - [Connecting the AC Adapter](#)
 - [Turning On the Computer](#)
-

Using the AC Adapter

The AC adapter converts AC power to the DC power required by the computer. The AC adapter kit includes the AC adapter with its attached DC cable (which inputs power to the computer) as well as an AC power cable that connects to an electrical outlet.

You can connect the AC adapter with your computer either turned on or off.

The AC adapter works with electrical outlets worldwide. However, power connectors vary among countries. Before you use AC power in a foreign country, you may need to obtain a new power cable designed for use in that country.

If the computer is docked to one of Dell's C/Port Family Advanced Port Replicators (APR) or C/Dock Family Expansion Stations, it obtains power through the APR or expansion station, which must be connected to an electrical outlet.

 **NOTE:** If you are running your computer on AC power with a battery installed, the AC adapter charges the battery (if needed) and then maintains the battery's charge.

NOTICE: The AC adapter should be in a ventilated area, such as on a desktop or on the floor, when used to power the computer or charge the battery. Do not use the AC adapter in a poorly ventilated environment, such as inside a carrying case.

Connecting the AC Adapter

1. Connect the AC adapter's attached cable into the computer's AC adapter connector (see [Figure 1](#)).
2. Plug the AC power cable into the other end of the AC adapter.
3. Plug the AC power cable into an electrical outlet.

Figure 1. Connecting the AC Adapter

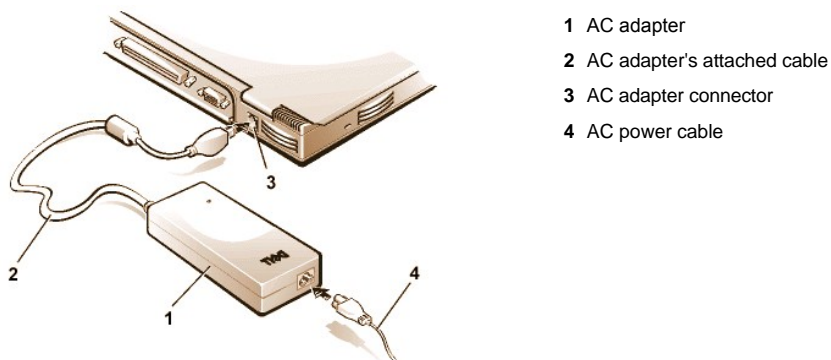

Turning On the Computer

To turn on the computer, press the [power button](#).

 **NOTE:** If your computer's operating system is "locked up"—that is, it does not respond to commands—press and hold down the power button for at least five seconds to turn off the computer.

[Back to Contents Page](#)

Power Management Settings: Dell™ Latitude™ CS/CSx Portable Computers User's Guide

[Experimenting With Power Conservation](#)

[Standby Mode](#)

[Using Key Combinations](#)

[Suspend-to-Disk Mode](#)

[Closing the Display](#)

[Power Management Properties for Microsoft Windows 98](#)

[Suspend Mode](#)

[Power Management Properties for Microsoft Windows NT](#)

Experimenting With Power Conservation

In general, the lower the value you set for each power conservation feature, the longer the battery's charge lasts. On the other hand, setting high values tends to optimize the computer's performance.

To evaluate the way that different settings affect how long you can operate the computer on battery power versus the relative efficiency of how the software performs, experiment as follows:

- 1 Use the computer with all the options set at their default values.
- 1 Use the computer with all the options disabled or set to **Off**.
- 1 Use the computer with all the options set to their minimum or maximum values.

Using Key Combinations

[Table 1](#) identifies the power management key combinations.

 **NOTE:** To use key combinations on an external keyboard, enable the [External Hot Key](#) option in the System Setup program, and press <Scroll Lock> instead of <Fn>.

Table 1. Key Combinations to Activate/Deactivate Features

Feature	Activate/Deactivate
Turn off display	To activate, press <Fn><d>.* To deactivate, move the cursor or press a key on the integrated or external keyboard. (If nothing happens, the computer may be in suspend or standby mode. Press the power button to resume normal operation.)
Turn off hard-disk drive	To activate, press <Fn><h>.* Automatically deactivates when the hard-disk drive is accessed. <i>NOTE: If a modular hard-disk drive is installed in the C/Dock media bay, you cannot turn off the hard-disk drive by pressing <Fn><h>.</i>
Suspend mode	To activate, press <Fn><Esc>. To deactivate, press the power button.
Suspend-to-disk mode	To activate, press <Fn><a>. (On a French keyboard, press <Fn><q>.)* To deactivate, press the power button.

* These key combinations do not function with the Advanced Configuration and Power Interface (ACPI).

Closing the Display

One way to conserve power on the computer is to close the display when the computer is not in use. When you close the display and an external

monitor is *not* connected, the computer's display shuts off and the computer enters [suspend](#) mode ([standby](#) mode in Microsoft® Windows® 98).

 **NOTE:** If an external monitor is connected when you close the display, the computer does not activate suspend mode. You can still use the external monitor.

To resume work, open the display. (The computer may take several seconds to resume operation.)

Suspend Mode

If your computer is running the Microsoft Windows 95 or Microsoft Windows NT® operating system, suspend mode stops almost all computer activity, but leaves the computer ready to resume operations immediately in about 20 to 30 seconds. Use suspend mode whenever you leave the computer unattended.

NOTICE: Windows 95 and Windows NT save data to random-access memory (RAM), not to your hard-disk drive, before entering suspend mode. If the computer enters suspend mode while running on battery power, data loss from RAM can occur if the battery discharges completely.

Suspend mode conserves battery power by turning off the microprocessor clock; the display; the hard-disk drive; the CD-ROM, DVD-ROM, or LS-120 drive module (if installed); the external monitor connector; the external keyboard (if attached); the parallel port; the serial port; the touch pad; and the diskette drive.

You can enter suspend mode immediately by pressing <Fn><Esc> (or <Scroll Lock><Esc> on an external keyboard if the [External Hot Key](#) option is enabled in the System Setup program).

When you enter suspend mode, the [power indicator](#) is not lit.

Resume from suspend mode by pressing the power button. The computer may take several seconds to return to normal operation.

 **NOTES:** On resumption from suspend mode, if a password is set, the computer displays the password prompt screen. At the password prompt screen, if you do not enter a password within 2 minutes, the computer returns to suspend mode.

Suspend mode is known as standby mode under the Microsoft Windows 98 operating system.

Standby Mode

If your computer is running the Microsoft Windows 98 operating system, standby mode turns off the display, stops the hard-disk drive, and turns off other internal devices so that the computer uses less battery power. When the computer resumes operation from standby mode, the desktop is restored exactly as it was before entering standby mode.

NOTICE: Windows 98 saves data to random-access memory (RAM), not to your hard-disk drive, before entering standby mode. If the computer enters standby mode while running on battery power, data loss from RAM can occur if the battery discharges completely.

You can enter standby mode by pressing <Fn><Esc>. To resume operation from standby mode, press the power button.

Suspend-to-Disk Mode

Suspend-to-disk (S2D) mode copies all system data to a reserved area—the S2D partition—on the hard-disk drive and then turns off all power to the computer. When you resume normal operation, the same programs will be running and the same files will be open that were loaded before you activated this mode.

Place the computer in S2D mode if you intend to store the computer for longer than 40 days. S2D mode preserves the configuration information stored in nonvolatile random-access memory (NVRAM). The reserve battery maintains this information, but it may run out of energy after 40 days.

 **NOTE:** S2D mode helps preserve system data by quickly saving it to the hard-disk drive if you are about to run out of battery power.

If your system is running under [Advanced Power Management](#) (APM) mode, and if the [External Hot Key](#) option is enabled in the System Setup program, you can enter S2D mode by pressing <Fn><a> (or <Scroll Lock><a> on an external keyboard). On a French keyboard, press <Fn><q> or <Scroll Lock><q>.*

Resume operation from S2D mode by pressing the power button.

If you connect or remove devices while the computer is in S2D mode, the computer automatically recognizes the newly connected devices when it resumes normal operation.

Some PC Cards may not operate correctly after resuming from S2D mode. If you encounter problems with a card, [remove and reinsert the card](#).

 **NOTE:** Dell creates an appropriately sized S2D partition before shipping the computer to you. Use the S2D utility to remove the file, to increase the size of the file, or to add the S2D file if you removed it. For more information about altering or creating an S2D file, see the

readme.S2D file, which can be found in the **Dell Utilities** folder on your hard-disk drive or on the S2D diskette that came with your computer.

* These key combinations may not function with future operating systems.

Power Management Properties for Windows 98

Windows 98 with Advanced Power Management (APM) provides the **Power Management Properties** window for setting power conservation features.

To access the **Power Management Properties** window and set the power management features, perform the following steps:

1. Click the **Start** button, point to **Settings**, and click **Control Panel**.
2. Double-click the **Power Management Properties** icon.

The **Power Management Properties** window contains the following tabs:

- 1 **Power Scheme** — allows you to change individual power management settings or select one of three power mode settings (**Always On**, **Home/Office Desk**, or **Portable/Laptop**) that each provide a set of default power management settings.
 - 1 **Alarms** — allows you to set the **Low Battery** and **Critical Battery** alarms to alert you when the computer battery falls below a certain percentage. When you received your computer, the **Low Battery** and **Critical Battery** alarm options were not checked. Dell recommends that you do not select these options.
 - 1 **Power Meter** — allows you to view the percentage of battery life remaining when your computer is operating on battery power. If your computer is operating on AC power, the computer displays a message.
 - 1 **Advanced** — allows you to display the **Power Meter** on the Windows 98 taskbar and to display a password prompt when the computer resumes operation from standby mode.
-

Power Management Properties for Microsoft Windows NT

Dell provides Softex software compatible with the Power Management Controller, which allows you to suspend and resume your portable computer without affecting your ability to use the docking station or its media bay.

For information about Softex power management software, see the Softex user's guides at <http://www.dell.com/products/notebook/latitude/NT40.htm> and see your *Dell-Installed Microsoft Windows NT Workstation Setup Guide*.

[Back to Contents Page](#)

[Back to Contents Page](#)

Batteries: Dell™ Latitude™ CS/CSx Portable Computers User's Guide

- [About the Batteries](#)
 - [Using the Battery](#)
 - [Charging the Battery](#)
 - [Charging a Hot Battery](#)
 - [Replacing the Battery](#)
 - [Battery Charge Gauge](#)
 - [First Low-Battery Warning](#)
 - [Second Low-Battery Warning](#)
 - [Detecting Battery Problems](#)
 - [Battery Disposal](#)
 - [About Battery Power](#)
 - [Turning On the Computer](#)
-

About the Batteries

Your computer includes a standard (34-watt/hour [WH]) or high-capacity (46-WH) lithium ion battery that provides power when an electrical outlet is not available. The battery is installed on the underside of the computer and forms part of the bottom of the computer. Lithium ion batteries are longer lived than conventional batteries and do not require replacement as often. Lithium ion batteries do not have the memory effect that is exhibited by nickel-metal hydride (NiMH) and nickel-cadmium (NiCD) batteries. You do not need to drain a lithium ion battery completely before recharging it. A lithium ion battery will not forget at which point it is fully charged. NiMH and NiCD batteries may not charge fully if they are partially drained then recharged.

Do not place spent batteries with common household waste products. Contact local authorities for the location of a chemical waste collection program nearest you.

Keep the following information in mind when you are running your computer from the battery:

- 1 From a fully charged standard battery you can expect between 2.5 and 3 hours of battery life; from a fully charged high-capacity battery, you can expect up to 50 percent greater battery life. Actual performance varies, depending on which power management features are enabled and which application programs you are using.
- 1 The [integrated battery charge gauge](#) lets you check the charge status of an installed or uninstalled battery at any time.
- 1 The battery's self-test capability alerts you to battery conditions such as low charge.
- 1 There is no battery memory effect with lithium ion batteries — you can charge the battery whenever you like without fear of reducing its charge capacity.
- 1 A battery has a life span of up to 350 full charges and 2000 partial charges, provided it is charged at normal room temperature.



NOTE: The battery is designed to work with Dell Latitude CS/CSx portable computers only. Do not use the battery with other computers, and do not use batteries from other computers with the Dell Latitude CS/CSx.

Using the Battery

The battery is partially charged when you receive it. Dell recommends that you charge your battery to full capacity before using it to power the computer.

If you are powering the computer from a battery, try to conserve battery power. A number of factors affect battery operating time:

- 1 Power conservation features that you use
- 1 Type of display and microprocessor installed
- 1 Use of storage media
- 1 Number and type of PC Cards and other external devices that you use
- 1 Kinds of application programs that you run
- 1 Capacity of the memory modules that you install (the higher the capacity, the more power used)

When you activate [suspend](#) mode (known as [standby](#) in the Microsoft® Windows® 98 operating system), the computer can remain in suspend mode on battery power for approximately one week (if the battery was fully charged before activating suspend or standby mode).

If you are going to store the computer, disconnect all devices and turn off the computer. Remove the battery when you store your computer for an extended period of time. A battery will drain when not in use during prolonged storage. After a long storage period, recharge the battery fully before

you attempt to run your computer from battery power.

Charging the Battery

Each time you connect the computer to an electrical outlet or install a battery in a computer that is connected to an electrical outlet, the computer checks the battery's charge. The AC adapter charges the battery (if needed) and then maintains the battery's charge.

 **NOTE:** For maximum battery performance, charge the battery only at normal room temperature.

When installed in a computer connected to an electrical outlet, the battery immediately starts charging. The green power indicator remains steady while the AC adapter charges the battery. The indicator starts blinking when the express charge cycle is complete. While the indicator is blinking, the AC adapter provides a trickle charge to bring the battery to full capacity. The indicator continues to blink until you remove the battery or disconnect the computer from its electrical outlet.

NOTICE: If the battery status indicator flashes alternately green and amber while the computer is connected to an electrical outlet, disconnect the computer from the outlet and allow the computer and the battery to return to room temperature. Then reconnect the computer to its electrical outlet and continue charging the battery. If the computer is not allowed to return to room temperature, the battery stops charging before it reaches full capacity.

If the computer is turned off and connected to an electrical outlet through the AC adapter, it takes the AC adapter about 1 hour and 20 minutes to fully charge a battery that has been completely discharged. If the computer determines that the battery is near full capacity, the AC adapter skips the express-charging process and starts trickle-charging the battery. If the computer is on, it takes up to 2.5 hours to charge a fully discharged battery, depending on which devices you are using and which programs you are running.

 **NOTE:** You can leave the battery in the computer as long as you like. The battery's integrated circuitry prevents the battery from overcharging.

Charging a Hot Battery

Before you attempt to charge a battery that is hot (either from recent use or from being in a hot environment), note the following information:

- 1 A hot battery will not charge when you connect the AC adapter to the computer. This safety feature is important because charging a hot battery shortens the battery's life span and may damage the battery and the computer.
 - 1 If the battery status indicator flashes alternately green and amber, the battery is too hot to start charging. If this occurs, disconnect the computer from its electrical outlet and allow it and the battery to return to room temperature. Reconnect the computer to the electrical outlet and continue charging the battery.
 - 1 If the computer is not allowed to return to room temperature, the battery stops charging before it reaches its full capacity.
-

Replacing the Battery

NOTICE: To avoid data loss, do not remove the battery while the computer is turned on unless the computer is connected to an electrical outlet.

To replace a battery in the battery bay, perform the following steps (see [Figure 1](#)).

 **NOTES:** If necessary, print these instructions for reference before proceeding.

You cannot replace the battery while the computer is running on battery power. To replace the battery while the computer is running, you must connect the computer to an electrical outlet or enter [suspend](#) (or [standby](#)) mode or [suspend-to-disk](#) (S2D) mode.

1. If the computer is docked, undock it following your usual undocking procedure. (See the documentation that came with your docking device.)
2. If the computer is not docked, preserve your data in one of the following ways and then go to step 3.
 - 1 Connect the computer to an electrical outlet.
 - 1 Place the computer in suspend (or standby) mode by pressing <Fn><Esc> (or <Scroll Lock><Esc> on an external keyboard if the [External Hot Key](#) option is enabled in the System Setup program).
 - 1 Place the computer in S2D mode by pressing <Fn><a> (or <Fn><q> on a French keyboard). When the green power indicator turns off, continue to step 3.

NOTICE: If you choose to replace the battery with the computer in suspend (or standby) mode, you have up to 4 minutes to complete the battery replacement.

3. Remove the battery from the battery bay.

Close the computer display and turn the computer over. Slide the battery bay latch toward the unlock icon, causing the battery to pop up slightly on one side (see [Figure 1](#)). Continue to hold the latch in the unlock position with one hand while pivoting the battery up and out of the bay with the other hand. Release the latch.

Figure 1. Removing a Battery

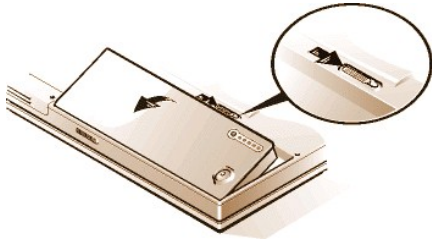

4. Position the new battery so that its three alignment tabs fit into the three slots in the outside wall of the computer, and lower the battery into its compartment. Make sure that the battery snaps into place, flush with the surrounding surface, and make sure that the battery latch is completely closed before turning the computer over.
5. If you put the computer into suspend mode or S2D mode in step 2, press the power button to resume normal operation.

Battery Charge Gauge

The battery charge gauge, located on the battery and accessible on the underside of the computer, consists of five indicators and a test button. Each indicator represents 20 percent of full charge. If only one indicator lights up, recharge the battery before using it.

To check the charge level, press the battery test button (see [Figure 2](#)). The appropriate number of indicators lights up for a few seconds to indicate the amount of charge remaining in the battery. For example, if three indicators light up, your battery has between 40 percent and 60 percent of its charge left.

Figure 2. Battery Charge Gauge

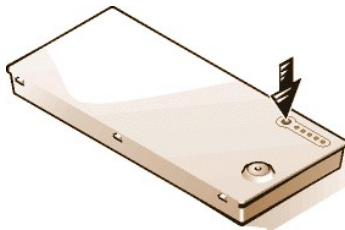

 **NOTES:** An indicator that blinks rapidly indicates a temporary failure or a potentially recoverable failure like overheating. Allow the battery to cool for several minutes before checking the charge level again.

If the battery has permanently failed or completely discharged, no charge gauge indicators will light when you press the battery test button. If you install a failed or completely discharged battery in the computer and the [battery status indicator](#) flashes amber rapidly, the battery has failed. If the battery status indicator turns solid green, allow the battery to charge overnight and check it the next day. If the battery is fully discharged, it takes a much longer time than usual to recharge it.

To purchase a new battery, [call Dell](#) or access the Dell World Wide Web site at <http://www.dell.com>. [Dispose](#) of the old battery properly.

Percentage of Charge

The [battery charge gauge](#) uses its five indicator lights to show the percent of charge remaining in the battery:

1. If one indicator lights up, the battery has 1 to 20 percent of its charge remaining.
 1. If two indicators light up, the battery has 21 to 40 percent of its charge remaining.
 1. If three indicators light up, the battery has 41 to 60 percent of its charge remaining.
 1. If four indicators light up, the battery has 61 to 80 percent of its charge remaining.
 1. If five indicators light up, the battery has 81 to 100 percent of its charge remaining.
-

First Low-Battery Warning

The first low-battery warning—a blinking amber battery status indicator—occurs when you have about 15 minutes of battery life left under current conditions and the computer is not connected to an electrical outlet.

Figure 3. Battery Status Indicator

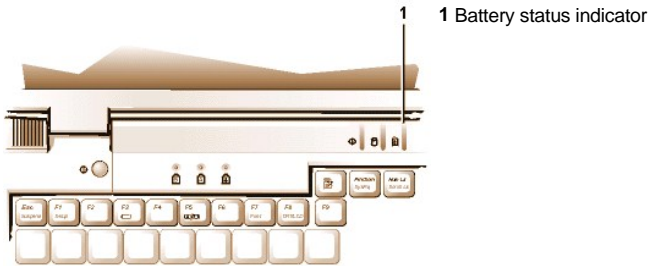

NOTICE: When you see a low-battery warning, save your work immediately. Then replace the battery or connect your computer to an electrical outlet.

Normally, if no input/output (I/O) activity occurs within 75 seconds after the first low-battery warning, the computer enters [S2D](#) mode. If the computer has no S2D partition, the computer enters [suspend](#) (or [standby](#)) mode, where it can preserve data for several hours.

Alternatively, you may have set the computer to enter S2D mode after a certain amount of time with no I/O activity. In this case the computer enters S2D mode before flashing the final low-battery warning.

Once S2D mode is activated, no further power is consumed.

NOTICE: Never turn off the computer while the drive access indicator is on. Doing so could cause data loss. Instead, close all of your application programs before you turn off the computer.

Second Low-Battery Warning

The second low-battery warning—a steady amber battery status indicator—occurs when you have about 5 minutes of battery life left under current conditions and the computer is not connected to an electrical outlet.

After the second low-battery warning, if no further I/O activity occurs within 15 seconds, the computer enters S2D mode. If the computer has no S2D partition, it enters suspend mode, in which it can preserve data for several hours.

If the computer is already in suspend mode when a final low-battery warning occurs, the computer enters S2D mode immediately. If S2D mode has been disabled, the computer reenters suspend mode.

NOTICE: To avoid losing data (and possibly corrupting data areas on your hard-disk drive), save your work immediately after a second low-battery warning. Then connect your computer to an electrical outlet, or place the computer in suspend mode. If the battery runs completely out of power, the computer shuts off without properly closing any open files.

Detecting Battery Problems

A battery problem may prevent the battery from being charged to its full potential and can lead to unpredictable operation. To obtain a new battery, [call Dell](#) or access the Dell World Wide Web site at <http://www.dell.com>.

Dell suggests you follow these precautions when using the battery:

- 1 To avoid installing a defective battery in your computer, first check the battery's charge, indicated by the battery charge indicators on the battery itself, by pressing the battery test button (see [Figure 2](#)).

 **NOTE:** If the battery has 0 (zero) percent charge, you cannot use the battery test button to check the battery's capacity. The battery gauge indicators will not light if the battery is completely drained.

- 1 If, after you insert the battery in the computer, the computer's battery status indicator (see [Figure 3](#)) flashes alternately green and amber, the battery is too hot to charge. Turn off the computer, and let the battery and computer cool to room temperature.
- 1 If, after you insert the battery in the computer, the computer's battery status indicator (see [Figure 3](#)) flashes amber for 4 seconds when you connect or disconnect the AC adapter or when you press the power button, you need to replace the battery.

- 1 If, after you insert the battery in the computer, the computer's battery status indicator (see [Figure 3](#)) flashes rapidly amber, the battery is defective and needs to be replaced.
-

Battery Disposal

When your battery no longer holds a charge, call your local waste disposal agency or environmental agency for advice on disposing the computer's lithium ion battery.

 **CAUTION: Do not puncture or incinerate the battery.**

 **NOTE:** This computer is supplied with a lithium ion battery. Lithium ion batteries are longer lived than conventional batteries and do not require replacement as often. Do not place spent batteries in common household waste products. Contact local authorities for the location of a chemical waste collection program nearest you. To purchase a new battery, [call Dell](#) or access the Dell World Wide Web site at <http://www.dell.com>.

About Battery Power

You automatically conserve battery power each time you connect the computer to an electrical outlet. The battery is even being recharged when you use AC power. The battery's life expectancy is largely determined by the number of charges it receives, so use an electrical outlet to run the computer whenever possible.

You can customize power management by individually controlling the computer's [power conservation features](#). These features reduce power consumption by monitoring application programs and computer devices for inactivity and slowing down or stopping some of the computer's internal devices.

 **NOTES:** When you use power conservation features, you often trade some of the performance of the computer for increased battery operating time. For example, if you turn off the hard-disk drive, you may experience a delay the next time the computer tries to access the hard-disk drive.

Other power conservation features, such as [suspend](#) (or [standby](#)) mode, stop almost all system activity. They allow you to maximize power conservation when your work is interrupted.

Experiment with power conservation features to achieve the optimum power conservation for your work environment.

Turning On the Computer

To turn on the computer, press the [power button](#).

 **NOTE:** If your computer's operating system is "locked up"—that is, it does not respond to commands—press and hold down the power button for at least five seconds to turn off the computer.

[Back to Contents Page](#)

[Back to Contents Page](#)

CD-ROM and DVD-ROM Drives: Dell™ Latitude™ CS/CSx Portable Computers User's Guide

 [Using CD-ROM and DVD-ROM Drives](#)

 [Caring for CDs and DVDs](#)

 [Types of Supported Discs](#)

Using CD-ROM and DVD-ROM Drives

CD-ROM and DVD-ROM drives are read-only devices that can play most commercially available 8- or 12-centimeter (cm) sound and video CDs. Dell installed the appropriate CD-ROM device drivers on your hard-disk drive. Dell also installed the drivers that will allow a DVD-ROM drive to play most CDs and read data from a DVD.

 **NOTE:** "Reading data" does not refer to playing a movie. However, if you are using the Microsoft® Windows® 95 or Windows 98 operating system, you can play DVD movies in your DVD-ROM drive by installing a zoomed video (ZV) PC Card, such as a hardware Moving Picture Experts Group (MPEG) decoder, in the upper PC card slot. You must also install the drivers that came with the card.

To use a CD-ROM or DVD-ROM drive, install it in the computer's [external media bay](#).

NOTICE: Protect the CD-ROM and DVD-ROM drives when they are not in the external media bay. Do not squeeze a drive or place objects on top of it; doing so could damage the drive motor. Keep the drive as clean as possible.

To play a CD or DVD, press the eject button on the face of the CD-ROM or DVD-ROM drive or press <Fn><F10>. When the tray slides out, place the disc into the tray, label side up. Make sure that the CD or DVD is seated correctly on the spindle by pressing down on the disc until it clicks in place. Then gently push in the tray.

NOTICE: If the CD or DVD is not seated correctly, the disc or drive can be damaged.

NOTICE: Do not use the CD-ROM or DVD-ROM drive while the computer is in motion. Doing so could interrupt the flow of data between the CD-ROM or DVD-ROM drive and the hard-disk or diskette drive.

When the CD-ROM or DVD-ROM drive is in use, the [drive access indicator](#) blinks.

If you are using the Microsoft Windows 95 or Windows 98 operating system, disable the autoplay feature while you use the CD-ROM or DVD-ROM drive. (The autoplay feature can interfere with the computer's [power management](#) functions.) If Dell installed the operating system, the autoplay feature has been disabled. If you reinstall the operating system or if you installed it yourself, be sure to disable the autoplay feature if you want to use the CD-ROM or DVD-ROM drive.

For instructions on changing the **Auto Insert Notification** option, see the operating system user's guide.

Caring for CDs and DVDs

When handling and using CDs and DVDs, follow these precautions:

- 1 Never use a damaged or warped CD or DVD.
 - 1 Always hold the CD or DVD by its edges. Do not touch the surface of the disc.
 - 1 Use a clean, dry cloth to remove dust, smudges, or fingerprints from the surface of the CD or DVD. When cleaning, wipe from the center of the CD or DVD to the edge.
 - 1 Never use solvents, such as benzene, record cleaners, or antistatic sprays, to clean the CD or DVD.
 - 1 Do not write on the surface of the CD or DVD.
 - 1 Store CD or DVDs in their containers, placing them in a cool, dry place. Extreme temperatures may damage CDs or DVDs.
 - 1 Do not bend or drop a CD or DVD.
 - 1 Do not place objects on top of a CD or DVD.
-

Types of Supported Discs

Your computer's CD-ROM and DVD-ROM drives are able to play the following disc formats:

- 1 CD-ROM red-book audio discs (CD-DA)
 - 1 CD-ROM yellow-book mode-1 and mode-2 data discs
 - 1 CD-ROM XA (mode-2 form 1 and form 2; without Adaptive Differential Pulse Code modulation [ADPCM])
 - 1 CD-I (mode-2 form 1 and form 2)
 - 1 CD-I Ready
 - 1 CD-Bridge
 - 1 Photo CD, CD-recordable (CD-R) (single and multisession)
 - 1 Video CD
 - 1 CD-rewritable (CD-RW). The 24x CD-ROM and DVD-ROM drives support reading CD-RW discs. This format is supported as read-only; neither the CD-ROM nor the DVD-ROM drive can write to CD-RW discs.
 - 1 DVD-5 (the DVD-ROM drive supports the DVD-5 format)
-

[Back to Contents Page](#)

[Back to Contents Page](#)

Contacting Dell: Dell™ Latitude™ CS/CSx Portable Computers User's Guide

[Overview](#)

[Europe Contact Numbers](#)

[International Dialing Codes](#)

[Asia and Other Regions Contact Numbers](#)

[Americas Contact Numbers](#)

Overview

When you need to contact Dell, use the telephone numbers, codes, and electronic addresses provided in the following sections. "[International Dialing Codes](#)" provides the various codes required to make long-distance and international calls. "[Americas Contact Numbers](#)," "[Europe Contact Numbers](#)," and "[Asia and Other Regions Contact Numbers](#)" provide local telephone numbers, area codes, toll-free numbers, and E-mail addresses, if applicable, for each department or service available in various countries around the world.

If you are making a direct-dialed call to a location outside of your local telephone service area, determine which codes to use (if any) in "[International Dialing Codes](#)," in addition to the local numbers provided in the other sections.

For example, to place an international call from Paris, France to Bracknell, England, dial the international access code for France followed by the country code for the U.K., the city code for Bracknell, and then the local number as shown in the following illustration:



To place a long-distance call within your own country, use area codes instead of international access codes, country codes, and city codes. For example, to call Paris, France from Montpellier, France, dial the area code plus the local number as shown in the following illustration:



The codes required depend on where you are calling from as well as the destination of your call; in addition, each country has a different dialing protocol. If you need assistance in determining which codes to use, contact a local or an international operator.

 **NOTES:** Toll-free numbers are for use only within the country for which they are listed. Area codes are most often used to call long distance within your own country (not internationally)—in other words, when your call originates in the same country you are calling.

Have your Express Service Code ready when you call. The code helps Dell's automated-support telephone system direct your call more efficiently.

International Dialing Codes

Click a listed country to obtain the appropriate contact numbers.

Country (City)	International Access Code	Country Code	City Code
Australia (Sydney)	0011	61	2
Austria (Vienna)	900	43	1
Belgium (Brussels)	00	32	2
Brazil	0021	55	51
Brunei	—	673	—
Canada (North York, Ontario)	011	—	Not required
Chile (Santiago)	—	56	2
China (Xiamen)	—	86	592
Czech Republic (Prague)	00	420	2
Denmark (Horsholm)	009	45	Not required
Finland (Helsinki)	990	358	9
France (Paris) (Montpellier)	00	33	(1) (4)

Germany (Langen)	00	49	6103
Hong Kong	001	852	Not required
Ireland (Bray)	16	353	1
Italy (Milan)	00	39	2
Japan (Kawasaki)	001	81	44
Korea (Seoul)	001	82	2
Luxembourg	00	352	—
Macau	—	853	Not required
Malaysia (Penang)	00	60	4
Mexico (Colonia Granada)	95	52	5
Netherlands (Amsterdam)	00	31	20
New Zealand	00	64	—
Norway (Lysaker)	095	47	Not required
Poland (Warsaw)	011	48	22
Singapore (Singapore)	005	65	Not required
South Africa (Johannesburg)	09/091	27	11
Spain (Madrid)	07	34	91
Sweden (Upplands Vasby)	009	46	8
Switzerland (Geneva)	00	41	22
Taiwan	002	886	—
Thailand	001	66	—
U.K. (Bracknell)	010	44	1344
U.S.A. (Austin, Texas)	011	1	Not required

Americas Contact Numbers

Country (City)	Department Name or Service	Area Code	Local Number or Toll-Free Number
Brazil	Sales, Customer Support, Technical Support		toll free: 0800 90 3355
Canada (North York, Ontario) <i>NOTE: Customers in Canada call the U.S.A. for access to TechConnect BBS.</i>	Automated Order-Status System		toll free: 1-800-433-9014
	AutoTech (Automated technical support)		toll free: 1-800-247-9362
	Customer Care (From outside Toronto)		toll free: 1-800-387-5759
	Customer Care (From within Toronto)	416	758-2400
	Customer Technical Support		toll free: 1-800-847-4096
	Sales (Direct Sales—from outside Toronto)		toll free: 1-800-387-5752
	Sales (Direct Sales—from within Toronto)	416	758-2200
	Sales (Federal government, education, and medical)		toll free: 1-800-567-7542
	Sales (Major Accounts)		toll free: 1-800-387-5755
	TechConnect BBS (Austin, Texas, U.S.A.)	512	728-8528
TechFax		toll free: 1-800-950-1329	
Chile (Santiago)	Sales, Customer Support, and Technical Support		toll free: 1230-020-4823

<p><i>NOTE: Customers in Chile call the U.S.A. for sales, customer, and technical assistance</i></p>			
<p>Latin America</p> <p><i>NOTE: Customers in Latin America call the U.S.A. for sales, customer, and technical assistance.</i></p>	Customer Technical Support (Austin, Texas, U.S.A.)	512	728-4093
	Customer Service (Austin, Texas, U.S.A.)	512	728-3619
	Fax (Technical Support and Customer Service) (Austin, Texas, U.S.A.)	512	728-3883
	Sales (Austin, Texas, U.S.A.)	512	728-4397
	SalesFax (Austin, Texas, U.S.A.)	512	728-4600 728-3772
<p>Mexico (Colonia Granada)</p> <p><i>NOTE: Customers in Mexico call the U.S.A. for access to the Automated Order-Status System and AutoTech.</i></p>	Automated Order-Status System (Austin, Texas, U.S.A.)	512	728-0685
	AutoTech (Automated technical support) (Austin, Texas, U.S.A.)	512	728-0686
	Customer Technical Support	525	228-7870
	Sales	525	228-7811 toll free: 91-800-900-37 toll free: 91-800-904-49
	Customer Service	525	228-7878
	Main	525	228-7800
<p>U.S.A. (Austin, Texas)</p>	Automated Order-Status System		toll free: 1-800-433-9014
	AutoTech (Automated technical support)		toll free: 1-800-247-9362
	Dell Home and Small Business Group:		
	Customer Technical Support (Return Material Authorization Numbers)		toll free: 1-800-624-9896
	Customer Service (Credit Return Authorization Numbers)		toll free: 1-800-624-9897
	National Accounts (systems purchased by established Dell national accounts [have your account number handy], medical institutions, or value-added resellers [VARs]):		
	Customer Service and Technical Support (Return Material Authorization Numbers)		toll free: 1-800-822-8965
	Public Americas International (systems purchased by governmental agencies [local, state, or federal] or educational institutions):		
	Customer Service and Technical Support (Return Material Authorization Numbers)		toll free: 1-800-234-1490
	Dell Sales		toll free: 1-800-289-3355 toll free: 1-800-879-3355

Spare Parts Sales		toll free: 1-800-357-3355
DellWare™		toll free: 1-800-753-7201
DellWare FaxBack Service	512	728-1681
Fee-Based Technical Support		toll free: 1-800-433-9005
Sales (Catalogs)		toll free: 1-800-426-5150
Fax		toll free: 1-800-727-8320
TechFax		toll free: 1-800-950-1329
TechConnect BBS	512	728-8528
Dell Services for the Deaf, Hard-of-Hearing, or Speech-Impaired		toll free: 1-877-DELLTTY (1-877-335-5889)
Switchboard	512	338-4400

Europe Contact Numbers

Country (City)	Department Name or Service	Area Code	Local Number or Toll-Free Number
Austria (Vienna) <i>NOTE:</i> <i>Customers in Austria call Langen, Germany for Technical Support and Customer Care.</i>	Switchboard	01	491 040
	Home/Small Business Sales	01	795676-02
	Home/Small Business Sales Fax	01	795676-05
	Home/Small Business Customer Care	01	795676-03
	Preferred Accounts/Corporate Customer Care		0660-8056
	Home/Small Business Technical Support	01	795676-04
	Preferred Accounts/Corporate Technical Support		0660-8779
	Web site: support.euro.dell.com/at		
	E-mail: tech_support_germany@dell.com		
Belgium (Brussels)	Technical Support	02	481 92 88
	Customer Care	02	481 91 19
	Home/Small Business Sales		toll free: 0800 16884
	Corporate Sales	02	481 91 00
	Fax	02	481 92 99
	Switchboard	02	481 91 00
	Web site: support.euro.dell.com/be		
	E-mail: tech_be@dell.com		
Czech Republic (Prague)	Technical Support	02	22 83 27 27
	Customer Care	02	22 83 27 11
	Fax	02	22 83 27 14
	TechFax	02	22 83 27 28
	Switchboard	02	22 83 27 11
	Web site: support.euro.dell.com/cz		
	E-mail: czech_dell@dell.com		
Denmark (Horsholm) <i>NOTE:</i> <i>Customers in Denmark call Sweden for fax</i>	Technical Support		45170182
	Customer Care		45170181
	Switchboard		45170100
	Fax Technical Support (Upplands Vasby, Sweden)		859005594

<i>technical support.</i>	Fax Switchboard		45170117
	Web site: support.euro.dell.com/dk		
	E-mail: den_support@dell.com		
Finland (Helsinki)	Technical Support	09	253 313 60
	Technical Support Fax	09	253 313 81
	Customer Care	09	253 313 61
	Fax	09	253 313 99
	Switchboard	09	253 313 00
	Web site: support.euro.dell.com/fi		
	E-mail: fin_support@dell.com		
France (Paris/Montpellier)	Technical Support	0803	387 270
	Customer Care (Paris)	01	47 62 68 92
	Customer Care (Montpellier)	04	67 06 61 96
	TechConnect BBS (Montpellier)	04	67 22 53 04
	Fax (Montpellier)	04	67 06 60 07
	Switchboard (Paris)	01	47 62 69 00
	Switchboard (Montpellier)	04	67 06 60 00
	Web site: support.euro.dell.com/fr		
	E-mail: web_fr_tech@dell.com		
Germany (Langen)	Technical Support	06103	971-200
	Technical Support Fax	06103	971-222
	Home/Small Business Customer Care	06103	971-530
	Corporate Customer Care	06103	971-560
	Preferred Accounts Customer Care	06103	971-420
	TechConnect BBS	06103	971-666
	Switchboard	06103	971-0
	Web site: http://www.dell.de/support		
	E-mail: tech_support_germany@dell.com		
Ireland (Bray) <i>NOTE: Customers in Ireland call the U.K. for Home/Small Business customer assistance.</i>	Technical Support		1-850-543-543
	Customer Care	01	204 4026
	Home/Small Business Customer Care (Bracknell, U.K.)		0870 906 0010
	Sales		1-850-235-235
	SalesFax	01	286 2020
	Fax	01	286 6848
	TechConnect BBS	01	204 4711
	TechFax	01	204 4708
	Switchboard	01	286 0500
	Web site: support.euro.dell.com/ie		
	E-mail: dell_direct_support@dell.com		
Italy (Milan)	Technical Support	2	57782.690
	Customer Care	2	57782.555
	Sales	2	57782.411
	Fax	2	57503530
	Switchboard	2	57782.1

	Web site: support.euro.dell.com/it		
	E-mail: support_italy@dell.com		
Luxembourg <i>NOTE: Customers in Luxembourg call Belgium for sales, customer, and technical assistance.</i>	Technical Support (Brussels, Belgium)	02	481 92 88
	Home/Small Business Sales (Brussels, Belgium)		toll free: 080016884
	Corporate Sales (Brussels, Belgium)	02	481 91 00
	Customer Care (Brussels, Belgium)	02	481 91 19
	Switchboard (Brussels, Belgium)	02	481 91 00
	Fax (Brussels, Belgium)	02	481 92 99
	Web site: support.euro.dell.com/be		
	E-mail: tech_be@dell.com		
Netherlands (Amsterdam)	Technical Support	020	581 8838
	Customer Care	020	581 8740
	Home/Small Business Sales		toll free: 0800-0663
	Home/Small Business SalesFax	020	682 7171
	Corporate Sales	020	581 8818
	Corporate SalesFax	020	686 8003
	Fax	020	686 8003
	Switchboard	020	581 8818
	Web site: support.euro.dell.com/nl		
Norway (Lysaker) <i>NOTE: Customers in Norway call Sweden for fax technical support.</i>	Technical Support		671 16882
	Customer Care		671 16881
	Switchboard		671 16800
	Fax Technical Support (Upplands Vasby, Sweden)		590 05 594
	Fax Switchboard		671 16865
	Web site: support.euro.dell.com/no		
	E-mail: nor_support@dell.com		
Poland (Warsaw)	Technical Support	22	60 61 999
	Customer Care	22	60 61 999
	Sales	22	60 61 999
	Switchboard	22	60 61 999
	Fax	22	60 61 998
	Web site: support.euro.dell.com/pl		
	E-mail: pl_support@dell.com		
Spain (Madrid)	Technical Support		902 100 130
	Corporate Customer Care		902 118 546
	Home/Small Business Customer Care		902 118 540
	TechConnect BBS	91	329 33 53
	Corporate Sales		902 100 185
	Home/Small Business Sales		902 118 541
	Switchboard	91	722 92 00
	Web site: support.euro.dell.com/es		
E-mail: es_support@dell.com			
Sweden (Upplands Vasby)	Technical Support	08	590 05 199
	Customer Care	08	590 05 169
	Fax Technical Support	08	590 05 594

	Sales	08	590 05 185
	Web site: support.euro.dell.com/se		
	E-mail: swe_support@dell.com		
Switzerland (Geneva)	Technical Support		0844 811 411
	Customer Care		0848 802 802
	Switchboard	022	799 01 01
	Fax	022	799 01 90
	Web site: support.euro.dell.com/ch		
	E-mail: swisstech@dell.com		
U.K. (Bracknell)	Technical Support		0870-908-0800
	Corporate Customer Care	01344	720206
	Home/Small Business Customer Care		0870-906-0010
	TechConnect BBS		0870-908-0610
	Sales	01344	720000
	AutoFax		0870-908-0510
	Web site: support.euro.dell.com/uk		
	E-mail: dell_direct_support@dell.com		

Asia and Other Regions Contact Numbers

Country (City)	Department Name or Service	Area Code	Local Number or Toll-Free Number
Australia (Sydney)	Customer Technical Support (Dell™ Dimension™ systems only)		1-300-65-55-33
	Customer Technical Support (Other systems)		toll free: 1-800-633-559
	Customer Care		toll free: 1-800-819-339
	Corporate Sales		toll free: 1-800-808-385
	Transaction Sales		toll free: 1-800-808-312
	Fax		toll free: 1-800-818-341
Brunei <i>NOTE: Customers in Brunei call Malaysia for customer assistance.</i>	Customer Technical Support (Penang, Malaysia)		810 4966
	Customer Service (Penang, Malaysia)		810 4949
	Transaction Sales (Penang, Malaysia)		810 4955
China (Xiamen)	Customer Service		toll free: 800 858 2437
	Sales		toll free: 800 858 2222
Hong Kong <i>NOTE: Customers in Hong Kong call Malaysia for customer assistance.</i>	Technical Support		toll free: 800 96 4107
	Customer Service (Penang, Malaysia)		810 4949
	Transaction Sales		toll free: 800 96 4109
	Corporate Sales		toll free: 800 96 4108
Japan (Kawasaki)	Technical Support		toll free: 0088-22-7890
	Technical Support (Server)		toll free: 0120-1984-35
	Technical Support (Dimension and Inspiron™)		toll free: 0120-1982-56
	Technical Support (WorkStation, OptiPlex™, and Latitude™)		toll free: 0120-1984-39
	Y2K Support	044	556-4298

	Customer Care	044	556-4240
	Direct Sales	044	556-3344
	Commercial Sales	044	556-3430 556-3440
	Faxbox Service		03-5972-5840
	Switchboard	044	556-4300
Korea (Seoul) <i>NOTE: Customers in Korea call Malaysia for customer assistance.</i>	Technical Support		toll free: 080-200-3800
	Transaction Sales		toll free: 080-200-3600
	Corporate Sales		toll free: 080-200-3900
	Customer Service (Penang, Malaysia)		810 4949
	Fax		394 3122
	Switchboard		287 5600
Macau <i>NOTE: Customers in Macau call Malaysia for customer assistance.</i>	Technical Support		toll free: 0800 582
	Customer Service (Penang, Malaysia)		810 4949
	Transaction Sales		toll free: 0800 581
Malaysia (Penang)	Technical Support		toll free: 1 800 888 298
	Customer Service	04	810 4949
	Transaction Sales		toll free: 1 800 888 202
	Corporate Sales		toll free: 1 800 888 213
New Zealand	Technical Support (Dell Dimension systems only) (\$2.50 + GST per call)		0900 51010
	Technical Support (Other systems)		0800 446 255
	Customer Service		0800 444 617
	Sales		0800 441 567
	Fax		0800 441 566
Singapore (Singapore) <i>NOTE: Customers in Singapore call Malaysia for customer assistance.</i>	Technical Support		toll free: 800 6011 051
	Customer Service (Penang, Malaysia)	04	810 4949
	Transaction Sales		toll free: 800 6011 054
	Corporate Sales		toll free: 800 6011 053
South Africa (Johannesburg)	Technical Support	011	709 7710
	Customer Care	011	709 7710
	Sales	011	706 7700
	Fax	011	709 0495
	Switchboard	011	709 7700
	Web site: support.euro.dell.com/za		
	E-mail: dell_za_support@dell.com		
Southeast Asian/Pacific Countries (excluding Australia, Brunei, China, Hong Kong, Japan, Korea, Macau, Malaysia, New Zealand, Singapore,	Customer Technical Support, Customer Service, and Sales (Penang, Malaysia)		60 4 810-4810

Taiwan, and Thailand—refer to individual listings for these countries)			
Taiwan	Technical Support		toll free: 0080 651 226/0800 33 557
<i>NOTE: Customers in Taiwan call Malaysia for customer assistance.</i>	Customer Service (Penang, Malaysia)		810 4949
	Transaction Sales		toll free: 0080 651 228/0800 33 556
	Corporate Sales		toll free: 0080 651 227/0800 33 555
Thailand	Technical Support		toll free: 0880 060 07
<i>NOTE: Customers in Thailand call Malaysia for customer assistance.</i>	Customer Service (Penang, Malaysia)		810 4949
	Sales		toll free: 0880 060 06

[Back to Contents Page](#)

[Back to Contents Page](#)

Customizing Your Computer: Dell™ Latitude™ CS/CSx Portable Computers User's Guide

- [Using the System Setup Program](#)
- [System Setup Options](#)
- [Power Management Settings](#)
- [Suspend-to-Disk Utility](#)

[Back to Contents Page](#)

[Back to Contents Page](#)

Dell™ Diagnostics: Dell Latitude™ CS/CSx Portable Computers User's Guide

- [Overview](#)
 - [Starting the Dell Diagnostics](#)
 - [Features of the Dell Diagnostics](#)
 - [Dell Diagnostics Main Screen Overview](#)
 - [When to Use the Dell Diagnostics](#)
 - [Confirming the System Configuration Information](#)
 - [Before You Start Testing](#)
 - [How to Use Dell Diagnostics](#)
-

Overview

Unlike many diagnostic programs, the Dell Diagnostics helps you check your computer's hardware without any additional equipment and without destroying any data. By using the diagnostics, you can have confidence in your computer's operation. And if you find a problem you cannot solve by yourself, the diagnostic tests can provide you with important information you will need when talking to Dell's service and support personnel.

NOTICE: Use the Dell Diagnostics to test only your Dell computer. Using this program with other computers may cause incorrect computer responses or result in error messages.

Features of the Dell Diagnostics

The Dell Diagnostics provides a series of menus and options from which you choose particular test groups or subtests. You can also control the sequence in which the tests are run. The diagnostic test groups or subtests also have these helpful features:

- 1 Options that let you run tests individually or collectively
 - 1 An option that allows you to choose the number of times a test group or subtest is repeated
 - 1 The ability to display or print out test results, or to save them in a file
 - 1 Options to temporarily suspend testing if an error is detected, or to terminate testing when an adjustable error limit is reached
 - 1 A **Devices** menu that briefly describes each test and its parameters
 - 1 A **Config** menu that describes the configuration of the devices in the selected device group
 - 1 Status messages that inform you whether test groups or subtests were completed successfully
 - 1 Error messages that appear if any problems are detected
-

When to Use the Dell Diagnostics

Whenever a major component or device in your computer does not function properly, you may have a component failure. As long as the microprocessor and the input and output components of your computer (the display, keyboard, and diskette drive) are working, you can use the Dell Diagnostics. If you are experienced with computers and know what component(s) you need to test, simply select the appropriate diagnostic test group(s) or subtest(s). If you are unsure about how to begin diagnosing a problem, read the rest of this section.

Before You Start Testing

If Dell installed the Microsoft® Windows® 95 or Windows 98 operating system on your computer's hard-disk drive, see the online help in Dell's **Program Diskette Maker** utility, which is available in the **Dell Accessories** group or folder, for instructions on making a program diskette set from the diskette image.

Refer to your operating system's documentation for information on how to duplicate diskettes. Put the original diskette away for safekeeping. Turn on your printer if one is attached, and make sure it is online. [Enter the System Setup program](#), confirm your computer's system configuration information, and enable all its components and devices, such as ports.

Starting the Dell Diagnostics

After you complete the preliminary instructions specified in "[Before You Start Testing](#)," perform the following steps to start the diagnostics:

1. Turn off the computer.
2. Insert the first diagnostics diskette into the diskette drive.
3. Turn on the computer.

 **NOTE:** Before you read the rest of this subsection, you may want to start the Dell Diagnostics so that you can see it on your display.

When you start the diagnostics, the Dell logo screen appears, followed by a message telling you that the diagnostics is loading. Follow the screen prompts to insert the second and third diskettes.

After the diagnostics loads, the **Diagnostics Menu** appears (see [Figure 1](#)). The menu allows you to run all or specific diagnostic tests or to exit to the MS-DOS® prompt.

For a quick check of your computer, select **Quickly Test All Devices**. This option runs only the subtests that do not require user interaction and that do not take a long time to run. Dell recommends that you choose this option first to increase the odds of tracing the source of the problem quickly. For a thorough check of your computer, select **Fully Test All Devices**. To check a particular area of your computer, select **Select Devices to Test**.

To select an option from this menu, highlight the option and press <Enter>, or press the key that corresponds to the highlighted letter in the option you choose.

Figure 1. Diagnostics Menu

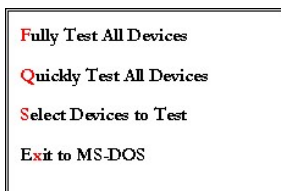

Dell Diagnostics Main Screen Overview

When you select **Select Devices to Test** from the **Diagnostics Menu**, the main screen of the diagnostics appears (see [Figure 2](#)). The main screen lists the diagnostic test device groups, lists the devices of the selected device group, and allows you to select categories from a menu. From this screen, you can enter two other types of screens.

Information on the main screen of the diagnostics is presented in the following five areas:

- 1 Two lines at the top of the screen identify the version number of the Dell Diagnostics.
- 1 On the left side of the screen, the **Device Groups** area lists the diagnostic test groups in the order they will run if you select **All** from the **Run tests** menu. Press the up- or down-arrow key to highlight a test device group.
- 1 On the right side of the screen, the **Devices for Highlighted Group** area lists the computer's currently detected hardware and some of the relevant settings.
- 1 The lower-right side of the screen displays information about your drive(s).
- 1 Two lines at the bottom of the screen make up the menu area. The first line lists the categories you can select; press the left- or right-arrow key to highlight a menu category. The second line gives information about the category currently highlighted.

 **NOTE:** The options displayed on your screen should reflect the hardware configuration of your computer.

Figure 2. Dell Diagnostics Main Screen



Confirming the System Configuration Information

When you boot your computer from your diagnostics diskette, the diagnostics checks your system configuration information and displays it in the **Device Groups** area on the main screen.

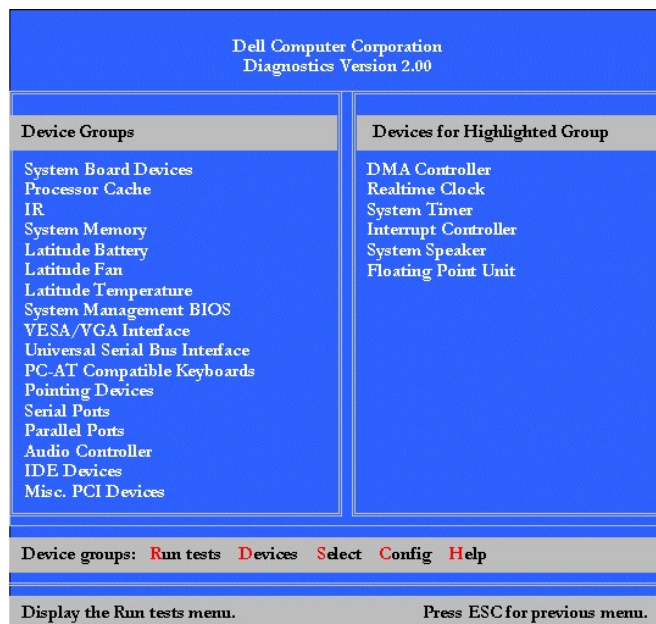
The following sources supply this configuration information for the diagnostics:

- 1 The system configuration information settings (stored in nonvolatile random-access memory [NVRAM]) that you selected while using the System Setup program
- 1 Identification tests of the microprocessor, the video controller, the keyboard controller, and other key components
- 1 Basic input/output system (BIOS) configuration information temporarily saved in RAM

Do not be concerned if the **Device Groups** area does not list the names of all the components or devices you know are part of your computer. For example, you may not see a printer listed, although you know one is attached to your computer. Because your printer is a parallel communications device, the computer recognizes the printer by its LPT1 address and identifies it as a parallel port. You can test your printer connection in the **Parallel Ports** tests.

How to Use Dell Diagnostics

Six comprehensive, menu-driven, online Help categories provide instructions on how to use the program and explain each menu item, test group, subtest, and test and error result. To enter the **Help** menu, perform the following steps:

1. Highlight **Select Devices to Test** in the **Diagnostics Menu**.
2. Press <Enter>.
3. Press <h>.

The **Help** menu categories are [Menu](#), [Keys](#), [Device Group](#), [Device](#), [Test](#), and [Versions](#). The online Help also provides detailed descriptions of the devices that you are testing. The **Help** categories are explained in the following subsections.

Menu Category

Menu describes the main menu screen area, the **Device Groups**, and the different diagnostic menus and commands and instructions on how to use them.

Keys Category

Keys explains the functions of the all of the keystrokes that can be used in Dell Diagnostics.

Device Group Category

Device Group describes the test group that is presently highlighted in the **Device Groups** list on the main menu screen. It also provides reasoning for using some tests.

Device Category

Device is the educational section of online Help. It describes the function and purpose of the highlighted device in the **Device Groups**.

For example, the following information appears when you select **Device** for **Diskette** in the **Device Groups** list:

Diskette drive A:

The diskette disk drive device reads and writes data to and from diskettes. Diskettes are flexible recording media, sometimes contained in hard shells. Diskette recording capacities are small and access times are slow relative to hard disk drives, but they provide a convenient means of storing and transferring data.

Test Category

Test provides a thorough explanation of the subtest for each selected device group. For example, the following description is provided for the **Diskette Drive Seek Test**:

Diskette drive A: - Diskette Drive Seek Test

This test verifies the drive's ability to position its read/write heads. The test operates in two passes: first, seeking from the beginning to ending cylinders inclusively, and second, seeking alternately from the beginning to ending cylinders with convergence towards the middle.

Versions Category

Versions lists the version numbers of the subtests that are used by the Dell Diagnostics.

[Back to Contents Page](#)

[Back to Contents Page](#)

Diskette Drive: Dell™ Latitude™ CS/CSx Portable Computers User's Guide

Your computer was shipped with a 3.5-inch diskette drive installed in the external media bay. For more information on using and installing devices in the external media bay, see "[Using the External Media Bay](#)."

The diskette drive lets you install programs and transfer data using 3.5-inch diskettes.

To use the diskette drive, insert a 3.5-inch diskette into the drive (label side up and metal end first). Push the diskette into the drive until the eject button extends outside the drive casing.

NOTICE: Do not travel with a diskette in the diskette drive. Doing so could break the eject button and damage the drive.

To remove a diskette from the drive, press the eject button to release the diskette, and then pull the diskette out of the drive.

When data is being accessed from the diskette drive, the [drive access indicator](#) blinks.



NOTE: As an alternative diskette drive configuration, you can [connect the diskette drive to the parallel connector](#) on the back of the computer using an optional cable available from Dell. If you are running either the Microsoft® Windows® 95 or Windows 98 operating system on your computer and the [Diskette Reconfig](#) option is enabled in the System Setup program, you do not have to reboot the computer when you connect the diskette drive to the parallel connector. If you are running the Microsoft Windows NT® operating system on your computer, reboot the computer after you connect the diskette drive.

[Back to Contents Page](#)

[Back to Contents Page](#)

Display: Dell™ Latitude™ CS/CSx Portable Computers User's Guide

- [Adjusting the Brightness](#)
- [Expanded Video Mode](#)
- [Video Drivers and Video Resolution](#)
- [Customizing Video Resolution](#)
- [Dual-Display Mode](#)
- [If You Have Display Problems](#)

Adjusting the Brightness

To adjust the brightness of the display, you can use the key combinations shown in [Table 1](#).



 **NOTE:** When you run the computer on battery power, set your computer's brightness control to the lowest setting that affords comfortable viewing. You can extend your battery life by using the minimum brightness setting.

Table 1. Brightness Key Combinations and Their Functions

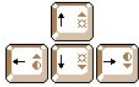

Key Combinations	Function
<Fn> + down arrow	Decreases brightness
<Fn> + up arrow	Increases brightness
<Fn> + right arrow	Has no effect on this computer
<Fn> + left arrow	Has no effect on this computer

 **NOTES:** You cannot change contrast on an active-matrix (thin film transistor [TFT]) display, such as your computer's display. (Contrast adjustments are only necessary on older passive-matrix displays.)

To use key combinations on an external keyboard, enable the [External Hot Key](#) option in the System Setup program and use <Scroll Lock> instead of <Fn>.

Expanded Video Mode

When working in text mode, you can select the font used to display text. Press <Fn><F7> to toggle between regular video mode and expanded video mode. In expanded video mode, items in resolutions other than 1024 x 768 expand to fill the screen, which is useful if you are working in 800 x 600 resolution on a 13.3-inch extended graphics array (XGA) display.

 **NOTES:** You may have difficulty using the display fonts feature with MS-DOS® programs that use downloaded fonts.

For optimum video performance in these cases, do not use expanded video mode.

Video Drivers and Video Resolution

The Dell-installed video drivers work with the operating system to let you customize the video resolution, number of screen colors, and refresh rate of your display.

 **NOTE:** The Dell-installed video drivers are designed to offer the best performance on your computer. Dell recommends that you use only these drivers with your factory-installed operating system.

Table 2. Combinations of Resolutions and Colors Supported

Resolution	Colors	Bits	Display Refresh Rate	External Monitor Refresh Rate
------------	--------	------	----------------------	-------------------------------

640 x 480	256	8	60 Hz	60 Hz, 75 Hz, 85 Hz
	65,536 (64 K)	16 (High Color)	60 Hz	60 Hz, 75 Hz, 85 Hz
	1677721 (16 Million)	24 (True Color)	60 Hz	60 Hz, 75 Hz, 85 Hz
800 x 600	256	8	60 Hz	60 Hz, 75 Hz, 85 Hz
	65,536 (64 K)	16 (High Color)	60 Hz	60 Hz, 75 Hz, 85 Hz
	1677721 (16 Million)	24 (True Color)	60 Hz	60 Hz, 75 Hz, 85 Hz
1024 x 768	256	8	60 Hz	60 Hz, 70 Hz, 75 Hz, 85 Hz
	65,536 (64 K)	16 (High Color)	60 Hz	60 Hz, 70 Hz, 75 Hz, 85 Hz
	1677721 (16 Million)	24 (True Color)	60 Hz	60 Hz, 70 Hz, 75 Hz, 85 Hz
1280 x 1024*	256	8	60 Hz	60 Hz

* In this resolution, the display is set to pan mode. To use 1280 x 1024 resolution, set the external monitor to **Plug and Play Monitor** as described in the following procedures.

For Windows 95, perform the following steps:

1. Click the **Start** button, point to **Settings**, and then click **Control Panel**.
2. Double-click the **Display** icon.
3. Click the **Settings** tab, click **Advanced Properties**, and click the **Monitor** tab.
4. Click **Change...**, click **Plug and Play Monitor**, and click **OK** twice.
5. Set **Display area** to **1280 x 1024**, and click **OK**.

For Windows 98, perform the following steps:

1. Click the **Start** button, point to **Settings**, and then click **Control Panel**.
2. Double-click the **Display** icon.
3. Click the **Settings** tab, click **Advanced...**, and click the **Monitor** tab.
4. Click **Change...**, click **Next**, and click **Display a list of all the drivers**.
5. Click **Next**, and click **Show all hardware**.
6. Under **Manufacturers**, click **(Standard monitor types)**.
7. Under **Models**, click **Plug & Play Monitor**; and click **Next**.
8. Click **Next** again, click **Finish**, and click **Close**.
9. At the **Display Properties** screen, set **Screen area** to **1280 x 1024**, and click **Apply**.
10. Click **OK**, click **Yes**, and click **OK**.

To display more colors, select a lower resolution. If you select a resolution and color combination that the computer does not support, the computer automatically selects the next supported combination.

Customizing Video Resolution

1. Click the **Start** button, point to **Settings**, and then click **Control Panel**.

The **Control Panel** window appears.

2. Double-click the **Display** icon.

The **Display Properties** window appears.

3. Click the **Settings** tab, and then set the resolution by dragging the slider in the **Desktop Area** box. In the **Color Palette** box, choose the number of colors from the menu provided. For more information, see your operating system documentation.

If you choose a resolution or color palette that is higher than is supported, the settings adjust automatically to the closest possible setting.

4. To change the refresh rate, click the **NeoMagic** tab, and then follow the instructions on your display.

 **NOTE:** You can adjust the refresh rate only on an external monitor. If the **NeoMagic** tab is inactive, your external monitor adjusts the refresh rate automatically.

Dual-Display Mode

With Microsoft® Windows® 98 and later operating systems, you can use an external monitor as an extension of your display (see your operating system documentation for more information). To set up your computer for dual-display mode, perform the following steps:

1. Connect the [external monitor](#).
2. Click the **Start** button, point to **Settings**, and then click **Control Panel**.
3. In the **Control Panel** window, double-click the **Display** icon.
4. In the **Display Properties** window, click the **Settings** tab.
5. Change the **Colors** option to **High Color (16 bit)**.
6. Change the **Desktop Area** to **1024 by 768 pixels**.
7. Click **Advanced...**
8. Click the **NeoMagic** tab.
9. Select the **Set Dual-Display** checkbox and click **Apply**.
10. Click **Yes** when prompted to restart your computer.
11. Click the **Start** button, point to **Settings**, and then click **Control Panel**.
12. Double-click **Display**, and then click the **Settings** tab.
Two display icons appear in the **Settings** window.
13. Click the display icon marked "2."
14. When asked if you want to enable this monitor, click **Yes**.
15. Click **Apply**, and then click **OK**.

If You Have Display Problems

If your computer is receiving power, but nothing appears on your display (such as light, text, or graphics) or the display image does not appear as you would expect, try the following measures to resolve the problem:

1. If the display is blank, you may be in suspend, standby, or suspend-to-disk mode. Press the power button to resume. If the display is blank and the power indicator is on, the display may have timed out. In this case, press any key on the keyboard to resume normal operation.
2. If the [low-battery warning](#) occurs, [connect](#) the AC adapter to the computer or replace the battery.
3. Adjust the brightness.
4. If your computer is attached to an external monitor, press <Fn><F8> to switch the video image to the display.

 **NOTE:** It takes several seconds to switch the video image.

[Back to Contents Page](#)

[Back to Contents Page](#)

Drivers: Dell™ Latitude™ CS/CSx Portable Computers User's Guide

 [Installing Microsoft® Windows® 95 and Windows 98 Drivers](#)

 [Installing Microsoft® Windows NT® Drivers](#)

 *NOTE: For more information on using the operating system installed on your computer by Dell, see the operating system user's guide that came with your computer.*

[Back to Contents Page](#)

Error Messages and Flash Codes: Dell™ Latitude™ CS/CSx Portable Computers User's Guide

[Error Messages](#)

[Memory Allocations](#)

[System Flash Codes](#)

[I/O Memory Map](#)

[Avoiding Interrupt Assignment Conflicts](#)

Error Messages

Your application programs, operating system, and the computer itself can identify problems and alert you to them. When this occurs, a message may appear on the computer's display or on an external monitor (if one is attached), or a flash code may be emitted.

If an error message appears on the display or external monitor, make a note of the message. For an explanation of the message and suggestions for correcting any errors, see [Table 1](#). The messages are listed alphabetically.

 **NOTE:** If the message is not listed in Table 1, see the documentation for the application program or the operating system documentation for an explanation of the message and a recommended action.

Table 1. System Error Messages

Message	Cause	Action
Auxiliary device failure	The touch pad or external PS/2 mouse may be faulty.	If you are using an external mouse only, check the connection for a loose or improperly connected cable. If the problem persists, enable the Pointing Device option. If the problem persists, call Dell for technical assistance.
Bad command or file name	The command you entered does not exist or is not in the pathname you specified.	Make sure that you have typed the command correctly, placed spaces in the proper location, and used the correct pathname.
Cache disabled due to failure	The primary cache internal to the microprocessor has failed.	Call Dell for technical assistance.
CD-ROM drive controller failure 1	The CD-ROM drive does not respond to commands from the computer.	Turn off the computer and detach the CD-ROM drive from the media bay connector. Reboot the computer. Turn off the computer again, reattach the CD-ROM drive to the computer, and verify the media-bay cable connection to the back of the CD-ROM drive. Reboot the computer. If the problem persists, run the CD-ROM Drive tests in the Dell Diagnostics .
Data error	The diskette or hard-disk drive cannot read the data.	Run the appropriate utility to check the file structure of the diskette drive or hard-disk drive. See the documentation that came with your operating system.
Decreasing available memory	One or more memory modules may be faulty or improperly seated.	Reseat the memory module in the upgrade socket. If the problem persists, remove the memory module from the upgrade socket. If the problem still persists, call Dell for technical assistance.
Disk C: failed initialization	The hard-disk drive failed initialization.	Remove and reseat the hard-disk drive , and reboot the computer. If the problem persists, boot from the diagnostics diskette and run the Hard-Disk Drive tests.
Diskette drive 0 seek failure	A cable may be loose, or the system configuration information may not match the hardware configuration.	Check and reseat the diskette drive cable. If the problem persists, run the Diskette Drive tests in the Dell Diagnostics and check the setting for the appropriate drive (Diskette Drive A or Diskette Drive B) in the System Setup program . If the problem cannot be corrected, call Dell for technical assistance.
Diskette read failure	A cable may be loose, or the diskette may be faulty.	If the diskette-drive access indicator lights up, try a different diskette.
Diskette subsystem reset failed	The diskette drive controller may be faulty.	Run the Diskette Drive tests in the Dell Diagnostics .
Diskette write-protected	Because the diskette is write-protected, the operation cannot be completed.	Slide the write-protect notch up.
Drive not ready	No diskette is in the diskette drive, or no hard-disk drive is in the drive bay. The operation requires a diskette in the drive	Put a diskette in the drive, or push the diskette all the way into the drive until the eject button pops out. Or, install a hard-disk drive in the drive bay.

	or a hard-disk drive in the bay before it can continue.	
Error reading PCMCIA card	The computer cannot identify the PC Card.	Reseat the card or try another PC Card that you know works.
Extended memory size has changed	The amount of memory recorded in NVRAM does not match the memory installed in the computer.	Reboot the computer. If the error appears on the display again, call Dell for technical assistance.
Gate A20 failure	An installed memory module may be loose.	Reseat the memory module in the upgrade socket. If the problem persists, remove the memory module from the upgrade socket. If the problem still persists, call Dell for technical assistance.
General failure	The operating system is unable to carry out the command.	This message is usually followed by specific information—for example, <i>Printer out of paper</i> . Respond by taking the appropriate action.
Hard-disk drive configuration error	The computer cannot identify the drive type.	Turn off the computer, remove the drive, and boot the computer from a bootable diskette. Then turn off the computer, reinstall the drive, and reboot the computer. Run the Hard-Disk Drive tests in the Dell Diagnostics .
Hard-disk drive controller failure 0	The hard-disk drive does not respond to commands from the computer.	Turn off the computer, remove the drive, and boot the computer from a bootable diskette. Then turn off the computer again, reinstall the drive, and reboot the computer. If the problem persists, try another drive. Then run the Hard-Disk Drive tests in the Dell Diagnostics .
Hard-disk drive failure	The hard-disk drive does not respond to commands from the computer.	Turn off the computer, remove the drive, and boot the computer from a bootable diskette. Then turn off the computer again, reinstall the drive, and reboot the computer. If the problem persists, try another drive. Then run the Hard-Disk Drive tests in the Dell Diagnostics .
Hard-disk drive read failure	The hard-disk drive may be faulty.	Turn off the computer, remove the drive, and boot the computer from a bootable diskette. Then turn off the computer again, reinstall the drive, and reboot the computer. If the problem persists, try another drive. Then run the Hard-Disk Drive tests in the Dell Diagnostics .
Invalid configuration information—please run System Setup Program	The system configuration information does not match the hardware configuration. This message is most likely to occur after a memory module is installed.	Correct the appropriate options in the System Setup program.
Keyboard clock line failure	A cable or connector may be loose, or the keyboard may be faulty.	Run the Keyboard Controller test in the Dell Diagnostics .
Keyboard controller failure	A cable or connector may be loose, or the keyboard may be faulty.	Reboot the computer, and avoid touching the keyboard or the mouse during the boot routine. If the problem persists, run the Keyboard Controller test in the Dell Diagnostics .
Keyboard data line failure	A cable or connector may be loose, or the keyboard may be faulty.	Run the Keyboard Controller test in the Dell Diagnostics .
Keyboard stuck key failure	If an external keyboard or keypad is being used, a cable or connector may be loose or the keyboard may be faulty. If the integrated keyboard is being used, the keyboard may be faulty. A key on the integrated keyboard or external keyboard may have been pressed while the computer was booting.	Run the Stuck Key test in the Dell Diagnostics .
Memory address line failure at address, read value expecting value	An installed memory module may be faulty or improperly seated.	Reseat the memory module in the upgrade socket. If the problem persists, remove the memory module from the upgrade socket. If the problem still persists, call Dell for technical assistance.
Memory allocation error	The software you are attempting to run is conflicting with the operating system, another application program, or a utility.	Turn off the computer, wait 30 seconds, and then restart it. Try to run the program again. If the problem persists, contact the software company.
Memory data line failure at address, read value expecting value	An installed memory module may be faulty or improperly seated.	Reseat the memory module in the upgrade socket. If the problem persists, remove the memory module from the upgrade socket. If the problem still persists, call Dell for technical assistance.
Memory double word logic failure at address, read value expecting value		

Memory odd/even logic failure at address, read value expecting value		
Memory write/read failure at address, read value expecting value		
No boot device available	The computer cannot find the diskette or hard-disk drive.	If the diskette drive is your boot device , make sure that there is a bootable diskette in the drive. If the hard-disk drive is your boot device, make sure that the drive is installed, properly seated, and partitioned as a boot device.
No boot sector on hard-disk drive	The operating system may be corrupted.	Reinstall your operating system. See the documentation that came with your operating system.
No timer tick interrupt	A chip on the system board may be malfunctioning.	Run the System Set tests in the Dell Diagnostics .
Non-system disk or disk error	The diskette in drive A or your hard-disk drive does not have a bootable operating system installed on it.	If you are trying to boot from the diskette, replace it with one that has a bootable operating system.
Not a boot diskette	There is no operating system on the diskette.	Boot the computer with a diskette that contains an operating system.
Optional ROM bad checksum	The optional ROM apparently failed.	Call Dell for technical assistance.
Sector not found	The operating system cannot locate a sector on the diskette or hard-disk drive. You probably have a bad sector or corrupted FAT on the diskette or hard-disk drive.	Run the appropriate utility to check the file structure on the diskette or hard-disk drive. If a large number of sectors are defective, back up the data (if possible), and then reformat the diskette or hard-disk drive.
Seek error	The operating system cannot find a specific track on the diskette or hard-disk drive.	If the error is on the diskette drive, try another diskette in the drive.
Shutdown failure	A chip on the system board may be malfunctioning.	Run the System Set tests in the Dell Diagnostics .
Time-of-day clock lost power	Data stored in NVRAM has become corrupted.	Connect your computer to an electrical outlet to charge the battery. If the problem persists, try to restore the data. To restore the data, press <Fn><F1> to enter the System Setup program . Then immediately exit it. If the message reappears, call Dell for technical assistance.
Time-of-day clock stopped	The reserve battery that supports the data stored in NVRAM may be dead.	Connect your computer to an electrical outlet to charge the battery. If the problem persists, call Dell for technical assistance.
Time-of-day not set-please run the System Setup program	The time or date stored in the System Setup program does not match the system clock.	Correct the settings for the Date and Time options. (For instructions, see " System Setup Program .")
Timer chip counter 2 failed	A chip on the system board may be malfunctioning.	Run the System Set tests in the Dell Diagnostics .
Unexpected interrupt in protected mode	The keyboard controller may be malfunctioning, or an installed memory module may be loose.	Run the System Memory tests and the Keyboard Controller test in the Dell Diagnostics .
Warning: Battery is critically low.	The battery is running out of charge.	Replace the battery , or connect the computer to an electrical outlet. Otherwise, activate suspend-to-disk mode or turn off the computer.

System Flash Codes

When errors that occur during the boot routine cannot be reported on the display or on an external monitor (if attached), the Num Lock, Caps Lock, and Scroll Lock indicators (see [Figure 1](#)) may flash together in a pattern of lights (or *flash code*) that identifies the problem. For example, one flash, followed by a second flash, and then a burst of three flashes (code 1-1-3) means that the computer was unable to read the data in nonvolatile random-access memory (NVRAM). This information is important to the Dell support staff if you need to call for technical assistance.

The Num Lock, Caps Lock, and Scroll Lock indicators flash briefly when the computer is turned on. The flash codes, if needed, occur after the boot routine.

Figure 1. Flash Code Indicators

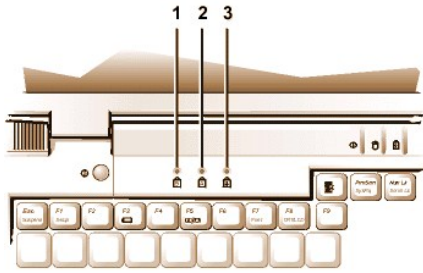

- 1 Num Lock
- 2 Caps Lock
- 3 Scroll Lock

When the computer emits a flash code, write it down on a copy of the [Diagnostics Checklist](#) and then look up its cause and meaning in [Table 2](#). If you are unable to resolve the problem, use the [Dell Diagnostics](#) to identify a more serious cause. If you are still unable to resolve the problem, [call Dell](#) for technical assistance.

Table 2. Flash Codes and Corrective Actions

Message	Cause	Action
1-1-3	NVRAM write/read failure.	Run the System Set tests in the Dell Diagnostics . If the program does not load, call Dell for technical assistance.
1-1-4	ROM BIOS checksum failure.	Run the System Set tests in the Dell Diagnostics . If the program does not load, call Dell for technical assistance.
1-2-1	Programmable interval timer failure.	Run the System Set tests in the Dell Diagnostics . If the program does not load, call Dell for technical assistance.
1-2-2	DMA initialization failure.	Run the System Set tests in the Dell Diagnostics . If the program does not load, call Dell for technical assistance.
1-2-3	DMA page register write/read failure.	Run the System Set tests in the Dell Diagnostics . If the program does not load, call Dell for technical assistance.
1-3-1 through 2-4-4	An installed memory module is not being properly identified or used.	Make sure that a memory module is installed in one of the memory module sockets on the system board. The computer will not function unless at least one memory module is installed.
3-1-1	Slave DMA register failure.	Run the System Set tests in the Dell Diagnostics . If the program does not load, call Dell for technical assistance.
3-1-2	Master DMA register failure.	Run the System Set tests in the Dell Diagnostics . If the program does not load, call Dell for technical assistance.
3-1-3	Master interrupt mask register failure.	Call Dell for technical assistance.
3-1-4	Slave interrupt mask register failure.	Call Dell for technical assistance.
3-2-4	Keyboard controller test failure.	Run the Keyboard Controller test in the Dell Diagnostics .
3-3-4	Display memory test failure.	Run the Video Memory test in the Dell Diagnostics .
3-4-1	Display initialization failure.	Run the Video tests in the Dell Diagnostics .
3-4-2	Display retrace test failure.	Run the Video tests in the Dell Diagnostics .
4-2-1	No timer tick.	Call Dell for technical assistance.
4-2-2	Shutdown failure.	Call Dell for technical assistance.
4-2-3	Gate A20 failure.	Call Dell for technical assistance.
4-2-4	Unexpected interrupt in protected mode.	Call Dell for technical assistance.
4-3-1	Memory failure above address 0FFFFh.	Run the System Memory tests in the Dell Diagnostics .
4-3-3	Timer chip counter 2 failure.	Call Dell for technical assistance.
4-3-4	Time-of-day clock stopped.	Call Dell for technical assistance.
4-4-1	Serial port failure.	Run the Serial/Infrared Ports tests in the Dell Diagnostics .
5-1-2	No usable memory.	Run the System Memory tests in the Dell Diagnostics .

Avoiding Interrupt Assignment Conflicts

Problems can arise if two devices attempt to use the same interrupt request (IRQ) line. To avoid this type of conflict, check the documentation for the default IRQ line setting for each installed device. Then consult [Table 3](#) to configure the device for one of the available IRQ lines.

 **NOTES:** Installed devices cannot share the same COM port address. The default address of your computer's serial port is COM1.

To view IRQ line assignments in the Microsoft® Windows® 95 and Windows 98 operating systems, click the **Start** button, point to **Settings**, and click **Control Panel**. Double-click the **System** icon. Select the **Device Manager** tab, and then double-click **Computer**.

Table 3. IRQ Line Assignments

IRQ Line	Reserved/Available
IRQ0	Reserved; generated by the system timer
IRQ1	Reserved; generated by the keyboard controller to signal that the keyboard output buffer is full
IRQ2	Reserved; generated internally by the interrupt controller to enable IRQ8 through IRQ15
IRQ3	Available for use by a PC Card unless the integrated serial port or infrared port is configured for COM2 or COM4
IRQ4	Available for use by a PC Card unless the integrated serial port or infrared port is configured for COM1 (the default) or COM3
IRQ5	Available for use by the audio controller
IRQ6	Generated by the diskette drive controller to indicate that the diskette drive requires the attention of the microprocessor
IRQ7	Available for use by a PC Card or audio controller if the parallel port is disabled
IRQ8	Reserved; generated by the system I/O controller's RTC
IRQ9	Reserved
IRQ10	Available for use by a PC Card or audio controller unless the C/Port Family APR or C/Dock Family Expansion Station is attached
IRQ11	Available for use by USB, PC Card, video controller, and audio controller
IRQ12	Reserved; generated by the keyboard controller to indicate that the output buffer of the touch pad or external PS/2 mouse is full
IRQ13	Reserved; generated by the math coprocessor
IRQ14	Reserved; generated by the hard-disk drive to indicate that the drive requires the attention of the microprocessor
IRQ15	Reserved; generated by CD-ROM drive in the external media bay to indicate that the drive requires the attention of the microprocessor

Memory Allocations

[Table 4](#) provides a map of the conventional memory area. When the microprocessor or a program addresses a location within the conventional memory range, it is physically addressing a location in main memory.

 **NOTE:** To view memory allocations in Windows 95 and Windows 98, click the **Start** button, point to **Settings**, and click **Control Panel**. Double-click the **System** icon. Click the **Device Manager** tab, and then double-click **Computer**.

Table 4. Conventional Memory Map

Address Range	Use
0000h-003FFh	Interrupt vector table
00400h-004FFh	BIOS data area
00500h-005FFh	MS-DOS® and BASIC work area
00600h-9FBFFh	User memory

[Table 5](#) provides a map of the upper memory area. Some of these addresses are dedicated to various system devices, such as the system/video basic input/output system (BIOS). Others are available for use by expansion cards and/or an expanded memory manager (EMM).

When the microprocessor or a program addresses a location within the upper memory area, it is physically addressing a location within one of these devices.

Table 5. Upper Memory Map

Address Range	Use
0009FC00-0009FFFF	PS/2-mouse data area
000A0000-000BFFFF	Video RAM
000C0000-000CBFFF	Video BIOS
000CC000-000CDFFF	PC Card
000F0000-000FFFFF	System BIOS

00100000-03FFFFFF	High memory area
FD000000-FDFFFFFF (approximate; not a fixed location)	Video RAM
FF200000-FF2FFFFFF (approximate; not a fixed location)	Video RAM
FFFE0000-FFFFFFF	BIOS ROM

I/O Memory Map

[Table 6](#) provides a map of memory addresses reserved by the computer for peripheral input/output (I/O) devices. Use the information in Table 6 to determine if the memory address of an external device (such as a PC Card) conflicts with a memory address reserved by the computer.

Check the documentation of the external I/O device to determine its memory address. If a device's memory address conflicts with a memory address reserved by the computer, change the address of the device.



*NOTE: To view I/O addresses in Windows 95 and Windows 98, click the **Start** button, point to **Settings**, and click **Control Panel**. Double-click the **System** icon. Click the **Device Manager** tab, and then double-click **Computer**.*

Table 6. I/O Memory Map

Address	Device
0000-001F	DMA controller #1
0020-003F	Interrupt controller #1
0040-005F	System timers
0060-0060	Keyboard controller
0061-0061	System speaker
0064-0064	Keyboard controller
0070-007F	RTC and NMI enable
0080-009F	DMA page registers
00A0-00BF	Interrupt controller #2
00C0-00DF	DMA controller #2
00F0-00FF	Math coprocessor
0170-0177	CD-ROM drive controller
01F0-01F7	Hard-disk drive controller
0210-0217	Audio controller
0220-022F	Audio controller
0270-0277	Fast IR
0376-0376	IDE controller
0378-037F	LPT1
0388-038B	Audio controller
03B0-03BB	VGA
03C0-03DF	VGA
03E0-03E1	PC Card controller
03E8-03EF	Fast IR
03F2-03F5; 03F7-03F7	Diskette controller
03F8-03FF	COM1
0530-0537	Audio controller
0778-077B	ECP registers
ECE0-ECFF	USB controller
FFA0-FFAF	PCI-IDE bus registers

Connecting External Devices: Dell™ Latitude™ CS/CSx Portable Computers User's Guide

- [About the I/O Connectors](#)
- [External Monitor](#)
- [Mouse, Keyboard, and External Numeric Keypad](#)
- [AC Adapter](#)
- [USB Devices](#)
- [Audio Devices](#)
- [Parallel Devices](#)
- [External Media Options](#)
- [Docking Devices](#)

About the I/O Connectors

You can connect external devices to the input/output (I/O) connectors. The computer's basic input/output system (BIOS) detects the presence of external devices when you boot (start) or reboot your computer. [Figure 1](#) shows the I/O connectors on the back of your computer; [Figure 2](#) shows the external media bay and audio connectors on the right side of the computer.

 **NOTES:** Some external devices require you to load software called device drivers into system memory before the devices will work. These device drivers help your computer recognize the external device and direct its operation. Instructions for installing this software are usually included in the upgrade kits.

The C/Port Family Advanced Port Replicator (APR) has the same I/O connectors as your computer. In addition, the C/Port APR has a second Personal System/2 (PS/2) connector, a second Universal Serial Bus (USB) connector, and an Ethernet network connector.

The C/Dock Family Expansion Station has the same I/O connectors as your computer. In addition, the C/Dock Expansion Station has a second PS/2 connector, a second USB connector, an Ethernet network connector, and a small computer system interface (SCSI) connector.

Figure 1. I/O Connectors On the Back of the Computer

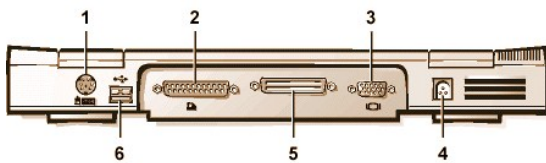

- 1 [PS/2 \(mini-DIN\) connector](#)
- 2 [Parallel connector](#)
- 3 [Video connector](#)
- 4 [AC adapter connector](#)
- 5 [Docking connector](#)
- 6 [USB connector](#)

Figure 2. I/O Connectors On the Right Side of the Computer

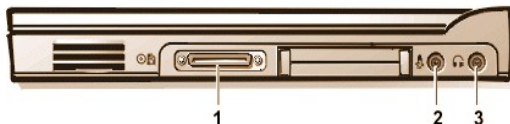

- 1 [External media bay connector](#)
- 2 [Microphone \(MIC IN\) jack](#)
- 3 [Speakers and headphones \(line-out/speaker-out\) jack](#)

Mouse, Keyboard, and External Numeric Keypad

You can attach a PS/2-compatible device such as a mouse, 101- or 102-key keyboard, or external numeric keypad to the mini-Deutsche Industrie Norm (DIN) PS/2 connector.

You can also connect these devices to the C/Port Family APR or the C/Dock Family Expansion Station.

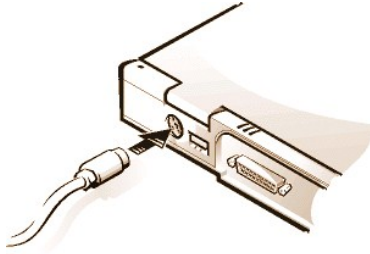

Mouse

 **NOTE:** If the computer is in suspend (or standby) or suspend-to-disk mode when you attach a mouse, you can use the mouse when the computer resumes normal operation. However, programs that were already running may need to be restarted to recognize the mouse. If the computer is not in suspend (or standby) or suspend-to-disk mode when you attach the mouse, you must reboot the computer to use the mouse.

When you attach a PS/2 mouse to the computer, the touch pad is automatically disabled. If you disconnect the mouse, you must shut down the computer or enter suspend or standby mode and then resume from it before the touch pad is operational. If you do not do this, the touch pad resumes operation in standard PS/2 mode, which means that many of the configuration features are disabled.

If you are using a PS/2-compatible mouse that is not made by Microsoft and the mouse does not work properly, reboot the computer. If the mouse still does not work, install the drivers from the diskette that came with the mouse and reboot the computer.

Keyboard

 **NOTE:** If the computer is in suspend (or standby) mode or suspend-to-disk mode when you attach an external keyboard, the device is recognized immediately by the computer when it resumes normal operation.

You can use the computer's keyboard and an external keyboard at the same time. When you attach a keyboard to the computer, the embedded numeric keypad is automatically disabled.

On an external keyboard, the <Scroll Lock> key acts the same way as the <Fn> key on the computer's keyboard (if the [External Hot Key](#) option is enabled in the System Setup program).

External Numeric Keypad

 **NOTE:** If the computer is in suspend (or standby) mode or suspend-to-disk mode when you attach an external numeric keypad, the device is recognized immediately by the computer when it resumes normal operation.

When you attach an external numeric keypad to the computer, the numeric keypad on the computer keyboard is automatically disabled. The indicators on the integrated keyboard track the operation of an external numeric keypad.

USB Devices

You can attach a USB hub device to the USB connector. The USB hub device can support multiple USB devices (typically low-speed peripherals such as mice, keyboards, printers, and computer speakers). The C/Port APR Family and the C/Dock Expansion Station Family docking solutions have two USB connectors.

 **NOTE:** If you are using a USB external keyboard, do not enter the System Setup program by using a keyboard command on an external keyboard. Instead, press <Fn><F1> on the computer's keyboard.

Parallel Devices

You can attach a parallel device (usually a printer) to the 25-hole parallel connector. You can also connect the diskette drive to the parallel connector.

The parallel port sends and receives data in parallel format, where eight data bits (one byte) are sent simultaneously over eight separate lines. The port can be configured as a unidirectional (output-only) port for devices such as a printer or as a bidirectional port for devices such as a network adapter.

The computer's integrated parallel port is designated as LPT1. The Microsoft® Windows® 95 and Windows 98 operating systems automatically recognize the parallel device and configure it correctly. The parallel port can also be configured for compatibility with the PS/2 standard.

Connecting a Diskette Drive to the Parallel Connector

You can use the the diskette drive as a second external device if you already have a device connected to the media bay connector. The diskette drive letter is A, unless a diskette drive is already installed in the external media bay, in which case the drive connected to the parallel connector is

drive B.

To connect the drive to the parallel connector on the I/O panel, use the optional parallel diskette-drive cable (available from Dell), as shown in Figure 5.

Figure 5. Connecting a Diskette Drive to the Parallel Connector

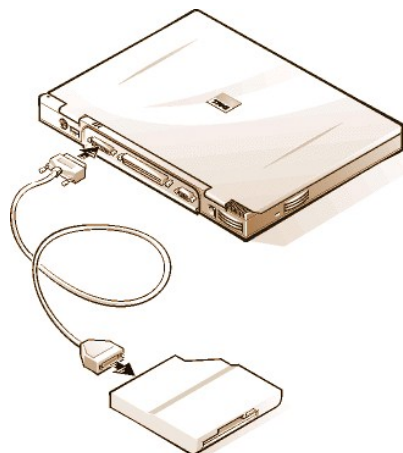

NOTICE: When the diskette drive is not being used externally, remove the parallel diskette-drive cable from the parallel connector.

NOTICE: Use the parallel diskette-drive cable only with the diskette drive. Do not try to connect any other device to the computer with this cable.

If the [Diskette Reconfig](#) option is set to **Any Time** in the System Setup program, you can connect the diskette drive to the parallel connector while the computer is turned on.

The drive access indicator does not blink when data is being accessed from the diskette drive connected to the parallel connector.

NOTICE: Protect the diskette drive when it is not in the external media bay. Do not squeeze the drive or place objects on top of it; doing so could damage the drive motor.

Docking Devices

You can attach your computer to Dell's C/Port Family APR and C/Dock Family Expansion Station docking devices through the docking connector. For information on docking your computer, see the documentation that came with your docking device.

External Monitor

You can use the 15-hole video connector to attach an external monitor to the computer.

Connecting an External Monitor

To attach an external monitor, perform the following steps.

NOTICE: Do not place the monitor directly on top of your portable computer, even if it is closed. Doing so can crack the computer case, the display, or both.

1. Make sure that the external monitor is turned off. Set the monitor on a monitor stand, desk top, or other level surface near your computer.
2. Connect the external monitor's video cable to the computer.

Plug the video cable connector into the matching video connector on the back of the computer, as shown in Figure 6. If the video cable is not permanently attached to the monitor, connect it to the monitor.

Figure 6. Connecting an External Monitor

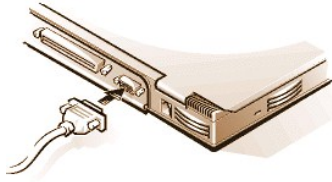

Be sure to tighten all the screws on the video cable connector(s) to eliminate radio frequency interference (RFI).

3. Connect your external monitor to a grounded electrical outlet.

Plug the three-prong connector on one end of the monitor's power cable into a grounded power strip or some other grounded power source. If the cable is not permanently attached to the monitor, connect it to the monitor.

You can also connect an external monitor to the C/Port Family APR or the C/Dock Family Expansion Station.

 **NOTE:** If you are using the Microsoft Windows 98 operating system, you can use an external monitor as an extension of your display. For more information, see the Windows 98 documentation or "[Dual-Display Mode](#)."

Using an External Monitor

When an external monitor is connected to the computer, the video image automatically appears on the external monitor's screen when you boot your computer.

To toggle the video image between the display, an external monitor, or both simultaneously, press <Fn><F8> on the keyboard. Press <Scroll Lock><F8> on an external keyboard if the [External Hot Key](#) option is enabled in the System Setup program.

If the external monitor is turned off when you boot your computer, the computer still sends the video image to the external monitor, but you will not see an image on either the computer's display or the external monitor. To see an image, turn on the external monitor or switch the video image to the computer's display by pressing <Fn><F8> on the keyboard or <Scroll Lock><F8> on an external keyboard if the **External Hot Key** option is enabled in the System Setup program.

 **NOTE:** If you are using your external monitor at a resolution greater than the display supports, the simultaneous display feature is disabled. To use the display, switch to a resolution that the computer supports, or disconnect the external monitor and restart your computer.

AC Adapter

You can attach the [AC adapter](#) to the computer by using the AC adapter connector. The AC adapter converts AC power to the DC power required by the computer.

You can connect the AC adapter with your computer turned either on or off.

The AC adapter works with electrical outlets worldwide. However, power connectors vary among countries. Before using AC power in a foreign country, you may need to obtain a new power cable designed for use in that country.

Audio Devices

You can connect audio devices such as speakers, microphones, and headphones to the two [audio jacks](#), as follows:

1. Connect the audio cable from a microphone to the microphone jack, also called the MIC IN jack.
1. Connect the audio cable from speakersto the headphones/speakers jack, also called the line-out/speaker-out jack.

 **NOTE:** The C/Port Family APR also has a headphones/speaker jack. The C/Dock Family Expansion Station has a line-in/audio-in jack as well as microphone and headphones/speaker jacks.

If your computer is running the Windows 95 operating system, you can control the sound on your computer through the **Dell Control Center Speaker** window, the [System Setup](#) program, and [key combinations](#).

External Media Options

You can connect [external media options](#) such CD-ROM, DVD-ROM, SuperDisk LS-120, and diskette drives to the external media bay connector.

[Back to Contents Page](#)

[Back to Contents Page](#)

Getting Help: Dell™ Latitude™ CS/CSx Portable Computers User's Guide

 [Help Overview](#)

 [Contacting Dell](#)

[Back to Contents Page](#)

[Back to Contents Page](#)

Help Overview: Dell™ Latitude™ CS Portable Computers User's Guide

 [Technical Assistance](#)

 [Product Information](#)

 [Help Tools](#)

 [Returning Items for Warranty Repair or Credit](#)

 [Problems With Your Order](#)

 [Before You Call](#)

Technical Assistance

If you need assistance with a technical problem, perform the following steps:

1. Run the Dell Diagnostics as described in "[Running the Dell Diagnostics](#)."
2. Make a copy of the [Diagnostics Checklist](#) and fill it out.
3. Use Dell's extensive suite of online services available at Dell's World Wide Web site (<http://www.dell.com>) for help with installation and troubleshooting procedures.
4. If the preceding steps have not resolved the problem and you need to talk to a Dell technician, call Dell's technical support service.

When prompted by Dell's automated telephone system, enter your Express Service Code to route the call directly to the proper support personnel. If you do not have an Express Service Code, open the **Dell Accessories** folder, double-click the **Express Service Code** icon, and follow the directions.

 *NOTE: Dell's Express Service Code system may not be available in all countries.*

For instructions on using the technical support service, refer to "[Technical Support Service](#)" and "[Before You Call](#)."

Help Tools

Dell provides a number of tools to assist you. These tools are described in the following sections.

 *NOTE: Some of the following tools are not always available in all locations outside the continental U.S. Please call your local Dell representative for information on availability.*

World Wide Web on the Internet

The Internet is your most powerful tool for obtaining information about your computer and other Dell products. Through the Internet, you can access most of the services described in this section, including AutoTech, TechFax, order status, technical support, and product information.

 From Dell's World Wide Web home page (<http://www.dell.com>), click the **Support** icon, and click **Support Your Dell**. Enter your service tag number (or, if you have one, your Express Service Code) and click **Submit**. If you don't have your service tag number or Express Service Code available, you can also select support information by system.

Everything you need to know about your system is presented on the system support page, including the following tools and information:

- 1 Technical information — Details on every aspect of your system, including hardware specifications.
- 1 Self-diagnostic tools — A system-specific troubleshooting application for resolving many computer-related issues by following interactive flowcharts.
- 1 Drivers, files, and utilities — The latest drivers and basic input/output system (BIOS) updates to keep your system functioning at its best.
- 1 Component support — Technical information, documentation, and troubleshooting tips for different system components.
- 1 Online communications center — Tool for submitting requests for both technical and nontechnical information on Dell products. Avoid telephone delays by receiving an e-mail response to your request for information if your computer is not functioning properly or if you have questions regarding your computer's hardware or operation.

Dell can be accessed electronically using the following addresses:

- 1 World Wide Web
<http://www.dell.com/>

<http://www.dell.com/ap/> (for Asian/Pacific countries only)

<http://www.euro.dell.com> (for Europe only)

- 1 Anonymous file transfer protocol (FTP)

<ftp.dell.com/>

Log in as user: anonymous, and use your e-mail address as your password.

- 1 Electronic Support Service

mobile_support@us.dell.com

apsupport@dell.com (for Asian/Pacific countries only)

support.euro.dell.com (for Europe only)

- 1 Electronic Quote Service

sales@dell.com

apmarketing@dell.com (for Asian/Pacific countries only)

- 1 Electronic Information Service

info@dell.com

AutoTech Service

Dell's automated technical support service—AutoTech—provides recorded answers to the questions most frequently asked by Dell customers.

When you call AutoTech, you use your touch-tone telephone to select the subjects that correspond to your questions. You can even interrupt an AutoTech session and continue the session later. The code number that the AutoTech service gives you allows you to continue your session where you ended it.

The AutoTech service is available 24 hours a day, seven days a week. You can also access this service through the technical support service. For the telephone number to call, refer to "[Contacting Dell](#)."

TechFax Service

Dell takes full advantage of fax technology to serve you better. Twenty-four hours a day, seven days a week, you can call the Dell TechFax line toll-free for all kinds of technical information.

Using a touch-tone phone, you can select from a full directory of topics. The technical information you request is sent within minutes to the fax number you designate. For the TechFax telephone number to call, refer to "[Contacting Dell](#)."

TechConnect BBS

Use your modem to access Dell's TechConnect bulletin board service (BBS) 24 hours a day, seven days a week. The service is menu-driven and fully interactive. The protocol parameters for the BBS are 1200 to 19.2K baud, 8 data bits, no parity, 1 stop bit.

Automated Order-Status System

You can call this automated service to check on the status of any Dell products that you have ordered. A recording prompts you for the information needed to locate and report on your order. For the telephone number to call, refer to "[Contacting Dell](#)."

Technical Support Service

Dell's industry-leading hardware technical support service is available 24 hours a day, seven days a week, to answer your questions about Dell hardware.

Our technical support staff pride themselves on their track record: more than 90 percent of all problems and questions are taken care of in just one toll-free call, usually in less than 10 minutes. When you call, our experts can refer to records kept on your Dell system to better understand your particular question. Our technical support staff use computer-based diagnostics to provide fast, accurate answers to questions.

To contact Dell's technical support service, first refer to "[Before You Call](#)" and then call the number for your country as listed in "[Contacting Dell](#)."

Problems With Your Order

If you have a problem with your order, such as missing parts, wrong parts, or incorrect billing, contact Dell for customer assistance. Have your invoice or packing slip handy when you call. For the telephone number to call, refer to "[Contacting Dell](#)."

Product Information

If you need information about additional products available from Dell, or if you would like to place an order, visit Dell's World Wide Web site at <http://www.dell.com>. For the telephone number to call to speak to a sales specialist, refer to "[Contacting Dell](#)."

Returning Items for Warranty Repair or Credit

Prepare all items being returned, whether for repair or credit, as follows:

1. Call Dell to obtain an authorization number, and write it clearly and prominently on the outside of the box.
For the telephone number to call, refer to "[Contacting Dell](#)."
2. Include a copy of the invoice and a letter describing the reason for the return.
3. Include a copy of the [Diagnostics Checklist](#) indicating the tests you have run and any error messages reported by the Dell Diagnostics.
4. Include any accessories that belong with the item(s) being returned (power cables, software diskettes, guides, and so on) if the return is for credit.
5. Pack the equipment to be returned in the original (or equivalent) packing materials.

You are responsible for paying shipping expenses. You are also responsible for insuring any product returned, and you assume the risk of loss during shipment to Dell. Collect On Delivery (C.O.D.) packages are not accepted.

Returns that are missing any of the preceding requirements will be refused at our receiving dock and returned to you.

Before You Call

 **NOTE:** Have your Express Service Code ready when you call. The code helps Dell's automated-support telephone system direct your call more efficiently.

Remember to fill out the [Diagnostics Checklist](#). If possible, turn on your system before you [call Dell](#) for technical assistance and call from a telephone at or near the computer. You may be asked to type some commands at the keyboard, relay detailed information during operations, or try other troubleshooting steps possible only at the computer system itself. Make sure the system documentation is available.

 **CAUTION:** If you need to remove the computer covers, be sure to first disconnect the computer system's power and modem cables from all electrical outlets.

Diagnostics Checklist

Date:
Name:
Address:
Phone number:
Service tag (bar code on the back of the computer):
Express Service Code:
Return Material Authorization Number (if provided by Dell support technician):
Operating system and version:
Peripherals:
Expansion cards:
Are you connected to a network? Yes No
Network, version, and network card:
Programs and versions:

Refer to your operating system documentation to determine the contents of the system's start-up files. If the computer is connected to a printer, print each file. Otherwise, record the contents of each file before calling Dell.

Error message, beep code, or diagnostic code:

Description of problem and troubleshooting procedures you performed:

[Back to Contents Page](#)

Introduction: Dell™ Latitude™ CS/CSx Portable Computers User's Guide

[Overview](#)

[Available Options](#)

[Features](#)

[Getting Help](#)

Overview

Dell Latitude CS and CSx portable computers are expandable multimedia systems designed around an Intel® Mobile Pentium® II microprocessor or an Intel Mobile Pentium III microprocessor, both with Peripheral Component Interconnect (PCI) technology. This section describes the major hardware and software features of your computer. [Figure 1](#), [Figure 2](#), and [Figure 3](#) show the front/right, back/left, and bottom views of the computer. [Figure 4](#) identifies the system status and keyboard status indicators.

Figure 1. Front/Right View of the Computer

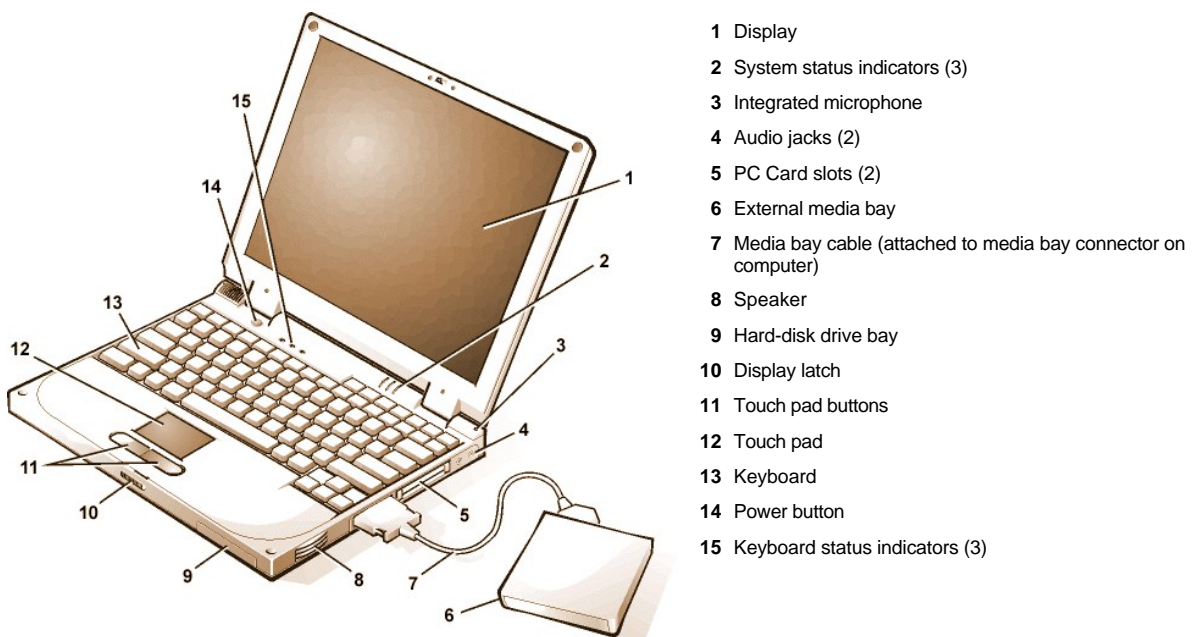
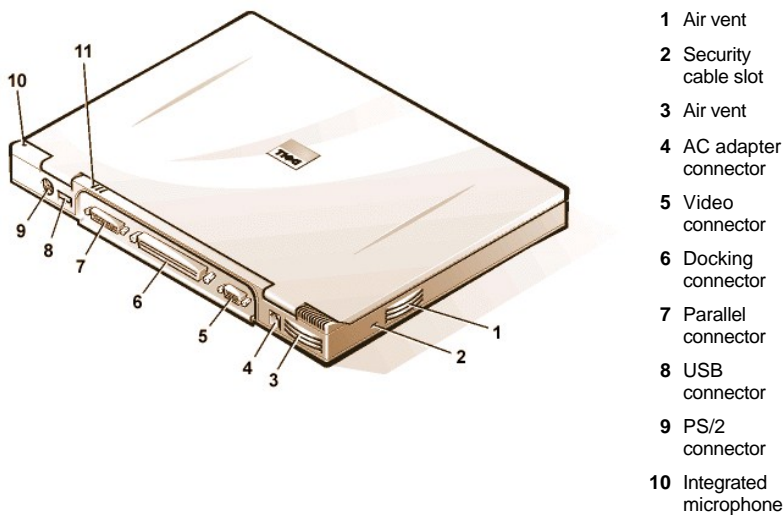
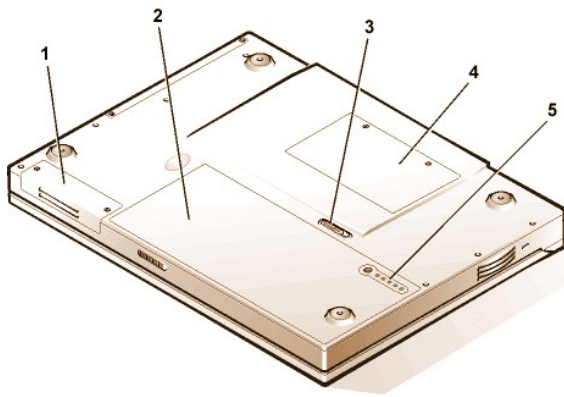

Figure 2. Back/Left View of the Computer



11 System status indicators

Figure 3. Bottom View of the Computer



- 1 Hard-disk drive bay
- 2 Battery
- 3 Battery latch
- 4 Memory module cover
- 5 Battery charge gauge

Figure 4. Indicator Panel Features

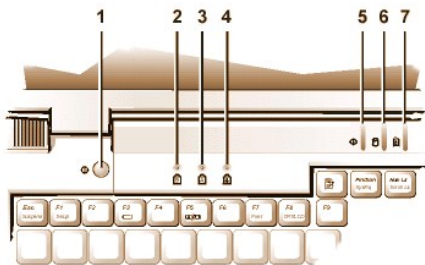

- 1 Power button
- 2 Num Lock indicator
- 3 Caps Lock indicator
- 4 Scroll Lock indicator
- 5 Power indicator
- 6 Drive access indicator
- 7 Battery status indicator

Features

Your Dell computer provides the following features:

- 1 Full multimedia capability through the following standard features:
 - o A 13.3-inch extended graphics array (XGA), 1024 x 768 thin film transistor (TFT) active-matrix color display
 - o An external media bay that supports storage devices such as a DVD-ROM, CD-ROM, diskette, SuperDisk LS-120, or second hard-disk drive
 - o  **NOTE:** For information on installing devices in the external media bay, see "[External Media Bay.](#)"
 - o 256-bit hardware-accelerated video support, with 4 megabytes (MB) of video memory
 - o Accelerated graphics port (AGP) architecture that increases the computer's video performance
 - o Support for a zoomed video (ZV) PC Card in the top PC Card slot
 - o Two audio jacks for connecting a microphone and external stereo speakers or headphones
 - o Integrated microphone and speaker
 - o Software wavetable support and Sound Blaster software-emulation capability
- 1 System memory consisting of synchronous dynamic random-access memory (SDRAM) small outline, dual-inline memory modules (SODIMMs). Factory-installed memory can range from 64 MB to a system maximum of 320 MB. Depending on the memory already installed, you may be able to increase memory by installing a 32-, 64-, or 128-MB SDRAM SODIMM in the memory upgrade socket. The achievable memory total for your computer depends on the computer's original memory configuration.
- 1 Two power conservation modes—*suspend (or standby) mode* and *suspend-to-disk mode*—that help you conserve battery power. If the

batteries run out of power, suspend-to-disk mode prevents data loss by copying all system data to the hard-disk drive and turning off the computer.

- 1 Connectors for two 3.3-volt (V) or 5-V PC Cards. The upper PC Card slot supports ZV PC Cards.

 **NOTE:** The PC Card controller supports the CardBus standard for 32-bit data transfer on the PC Card.

- 1 Hardware and software support for the Dell Latitude C/Port Family Advanced Port Replicator (APR) and the Dell Latitude C/Dock Family Expansion Station.
- 1 A touch-pad pointing device positioned for both left- and right-handed users. The left and right touch-pad buttons mimic mouse buttons; you can also perform many pointing functions by tapping the touch pad itself. Click-and-drag buttonless functions are supported.
- 1 A lithium ion battery in the battery bay. The Dell ExpressCharge™ technology charges a single battery in approximately 1 hour (when the computer is off or in suspend [or standby] mode).

 **NOTE:** The batteries are designed to work only with Dell Latitude CS/CSx portable computers. Do not use the batteries with other computers, and do not use batteries from other computers with the Dell Latitude CS/CSx.

 **CAUTION:** Do not puncture or incinerate the battery. When your battery no longer holds a charge, call your local waste disposal agency or environmental agency for advice on disposing of the computer's lithium ion battery. The lithium ion technology used in the battery is significantly less hazardous to the environment than the lithium metal technology used in some other batteries (such as watch batteries).

- 1 A high-performance parallel port and a multipurpose Personal System/2 (PS/2) connector for attaching external devices, a monitor connector for attaching an external monitor to your computer, and a Universal Serial Bus (USB) connector that supports stand-alone and hub devices.
- 1 An automatic thermal management system that uses a variable-speed fan and microprocessor speed changes to keep the system running at the optimum temperature.

The following software is included with your Dell computer:

- 1 The Microsoft® Windows® 95, Windows 98, or Windows NT® 4.0 or later operating system is installed on your hard-disk drive. For more information, see your operating system documentation.
- 1 The [System Setup program](#) lets you view and change the system configuration.
- 1 The Program Diskette Maker allows you to create program diskette sets of software that Dell installed on your computer's hard-disk drive.
- 1 [Dell Diagnostics](#) for evaluating the computer's components and devices.

 **NOTE:** If Dell did not install an operating system on your hard-disk drive, the drivers, system utilities, and diagnostics are available separately from Dell. To order them, see "[Getting Help](#)" for the appropriate telephone number in your location.

Available Options

Dell offers the following devices and upgrade options:

- 1 C/Port Family APRs and C/Dock Family Expansion Stations
- 1 Additional batteries
- 1 External keyboards and keypads
- 1 External monitors
- 1 External pointing devices
- 1 External speakers, headphones, and microphones
- 1 Printers
- 1 Dell Latitude C-Family storage devices such as hard-disk drives, additional hard-disk drives for the external media bay, CD-ROM drives, 4x DVD-ROM drives, and SuperDisk LS-120 drives
- 1 AC adapter
- 1 PC Cards
- 1 32-, 64-, and 128-MB memory upgrade modules
- 1 Carrying cases

Instructions for connecting or installing these options are included in the upgrade kit you receive from Dell. For more information on options available for your system, visit the Dell World Wide Web site at <http://www.dell.com>.

Getting Help

If at any time you don't understand a procedure described in this guide, or if your computer does not perform as expected, Dell provides a number of tools to help you. For more information on these help tools, see "[Getting Help](#)."

[Back to Contents Page](#)

Keyboard: Dell™ Latitude™ CS/CSx Portable Computers User's Guide

- [Embedded Numeric Keypad](#)
- [Speaker Key Combinations](#)
- [Display Key Combinations](#)
- [System Function Key Combinations](#)
- [Power Conservation Key Combinations](#)
- [CD-ROM and DVD-ROM Drive Key Combinations](#)
- [Processing Speed Key Combinations](#)

Embedded Numeric Keypad

As you work, you may want to use the embedded numeric keypad (see [Figure 1](#)) to enter numbers in spreadsheet or financial programs. The embedded numeric keypad shares some of the keys on your computer's keyboard. On these keys, the number and symbol characters of the numeric keypad appear in blue to the right of the main keypad characters. To activate the embedded numeric keypad, press <Num Lk> (the [Num Lock indicator](#) lights up).

Figure 1. Embedded Numeric Keypad



Some key combinations can be used whether or not the keypad is activated.

 **NOTE:** On an external keyboard, use <Scroll Lock> with the appropriate keys if the [External Hot Key](#) option is enabled in the System Setup program.

Use the numeric keypad combinations in Table 1 to enable and disable several numeric keypad functions.

Table 1. Embedded Numeric Keypad Key Combinations

When Keypad Is On	Function
<Num Lk>	Toggles the embedded numeric keypad off
<Fn><key>	Temporarily disables the embedded numeric keypad; enables the lowercase characters/functions of the keyboard
<Fn><Shift><key>	Temporarily disables the embedded numeric keypad; enables the uppercase characters/functions of the keyboard
When Keypad Is Off	Function
<Num Lk>	Toggles the embedded numeric keypad on
<Fn><Shift><number key>	Temporarily enables a number or symbol key in the embedded numeric keypad

Display Key Combinations

 **NOTE:** On an external keyboard, use <Scroll Lock> with the appropriate keys if the [External Hot Key](#) option is enabled in the System Setup program.

Use the key combinations in Table 2 to adjust the computer's display.

Table 2. Display Key Combinations

Key Combinations	Function
------------------	----------

<Fn> + down arrow	Incrementally decreases brightness.
<Fn> + up arrow	Incrementally increases brightness.
<Fn> + right arrow	Has no effect on your computer. Decreases contrast on passive-matrix displays; has no effect on active-matrix displays.
<Fn> + left arrow	Has no effect on your computer. Increases contrast on passive-matrix displays; has no effect on active-matrix displays.
<Fn><F5> *	Toggles the computer's display between regular video mode and reverse video mode (white on black). This key combination works only if the computer is in text mode; it has no effect if the computer is running a graphical operating system or application program.
<Fn><F7>	Toggles the computer's display between expanded video mode and regular video mode.
<Fn><F8>	Switches the video image to the next display in the following sequence: the display, an external monitor, or both displays simultaneously.
<Fn><d>*	Turns off the display.

* This key combination may not be supported by future operating systems.

 **NOTES:** Contrast cannot be changed on an active-matrix (thin film transistor [TFT]) display, such as the display in your computer.

To use key combinations on an external keyboard, enable the [External Hot Key](#) option in the System Setup program and use <Scroll Lock> instead of <Fn>.

Power Conservation Key Combinations

 **NOTE:** On an external keyboard, use <Scroll Lock> with the appropriate keys if the **External Hot Key** option is enabled in the System Setup program.

Use the key combinations in Table 3 to activate or turn off the computer's power conservation features.

Table 3. Power Conservation Key Combinations

Key Combinations	Function
<Fn><d>*	Turns off the display
<Fn><h>*	Turns off the hard-disk drive
<Fn><Esc>*	Activates suspend or standby mode
<Fn><a> or <Fn><q> on French keyboards	Activates suspend-to-disk mode

* This key combination may not be supported by future operating systems.

Processing Speed Key Combinations

 **NOTE:** On an external keyboard, use <Scroll Lock> with the appropriate keys if the [External Hot Key](#) option is enabled in the System Setup program.

Use the key combinations in Table 4 to change the computer's processing speed.

Table 4. Processing Speed Key Combinations

<Fn><I> *	Switches between the microprocessor's maximum speed and a slower compatibility speed
-----------	--

<Ctrl>< >	In full MS-DOS® mode or in a full-screen DOS box, switches between the microprocessor's maximum speed and a slower compatibility speed
-----------	--

* This key combination may not be supported by future operating systems.

Speaker Key Combinations

 **NOTE:** On an external keyboard, use <Scroll Lock> with the appropriate keys if the [External Hot Key](#) option is enabled in the System Setup program.

Use the key combinations in Table 5 to adjust the computer's speaker volume and to enable and disable the speakers.

Table 5. Speaker Key Combinations

Key Combinations	Function
<Fn><Page Up>	Increases the volume of the integrated speaker and the external speakers, if attached
<Fn><Page Dn>	Decreases the volume of the integrated speaker and the external speakers, if attached
<Fn><End>	Enables and disables the integrated speaker and the external speakers, if attached

System Function Key Combinations

 **NOTE:** On an external keyboard, use <Scroll Lock> with the appropriate keys if the [External Hot Key](#) option is enabled in the System Setup program.

Use the key combinations in Table 6 to access MS-DOS, open the System Setup program, and open the [Battery Status](#) screen of the System Setup program.

Table 6. System Function Key Combinations

Key Combinations	Function
<Ctrl><Alt>	Restarts (reboots) the computer in MS-DOS mode. In the Microsoft® Windows® 95, Windows 98, and Windows NT® operating systems, click the Start button and click Shut Down .
<Fn><F1>*	Opens the System Setup program.
<Fn><F3>*	Opens the Battery Status screen of the System Setup program.

* This key combination may not be supported by future operating systems.

CD-ROM and DVD-ROM Drive Key Combinations

 **NOTE:** On an external keyboard, use <Scroll Lock> with the appropriate keys if the [External Hot Key](#) option is enabled in the System Setup program.

To eject the CD-ROM or DVD-ROM tray, press <Fn><F10>.

[Back to Contents Page](#)

External Media Bay: Dell™ Latitude™ CS/CSx Portable Computers User's Guide

- [Using the External Media Bay](#)
 - [Setting Up a Second Hard-Disk Drive](#)
-

Using the External Media Bay

You can use the external media bay (see [Figure 1](#)) for the diskette drive that comes with your system. Alternatively, you can install an optional device (such as a CD-ROM, DVD-ROM, SuperDisk LS-120, or second hard-disk drive) in the bay.

 **NOTE:** *If desired, you can use the media bay cable to connect a device directly to the external media bay connector, without using the external media bay.*

To install a device in the external media bay, perform the following steps:

1. *If your computer is running the Dell-installed Microsoft® Windows NT® operating system with Softex Docking Services, or if it is running the Dell-installed Microsoft Windows® 95 or Windows 98 operating system with Softex Bay Manager:* Right-click the Softex icon (the icon looks like a tiny open portable computer) in the system tray at the bottom right on your display, and select either **Remove or Swap Devices** or **Insert Bay Devices**.

If your computer is not running one of the Softex programs: Save your work, close all open files and application programs, and turn off the computer.

NOTICE: When a device is not inside the external media bay, it is fragile and must be handled carefully to avoid damage. Do not press down on it or place a heavy object on top of it. Place the device in a travel case to keep it free of dust and liquids. Store the device in a safe place.

2. If the external media bay contains a device, remove the media bay cable from the back of the bay. Then remove the device by sliding the release latch on the bottom of the bay to the release position, holding it there, and pulling the device out of the bay.
3. Slide the new device firmly into the external media bay.

You should hear a click when the device is fully seated.

4. Connect the media bay cable.

Position the larger of the cable connectors with its shiny metal lip down, and connect it firmly to the back of the device through the slot in the back of the bay. Make sure that the securing clips are fully engaged and the connector is fully seated. Make sure that the other end of the cable is connected to the media bay connector on the right-hand side of the computer (see [Figure 1](#)).

Figure 1. External Media Bay

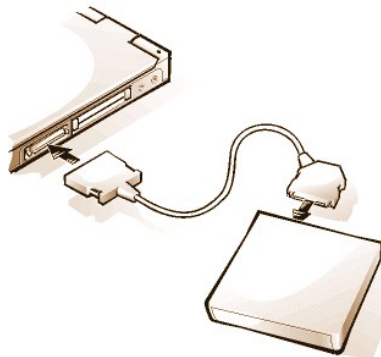

5. *If your computer is running Softex Docking Services or Softex Bay Manager:* Click **OK** at the **Softex Docking Services** or **Softex Bay Manager** screen. Click **OK** at the **Device Removal** screen (if it appears), and then click **OK** at the **Device Configured** screen.

If you turned off the computer in step 1: Press the power button to turn the computer back on.

 **NOTE:** *For the latest information on Softex Docking Services software, see <http://www.dell.com/products/notebook/latitude/NT40.htm>.*

Setting Up a Second Hard-Disk Drive

The first time you install a second hard-disk drive in the external media bay, you must format that drive. For instructions, see the documentation that came with the device.

[Back to Contents Page](#)

[Back to Contents Page](#)

Media Options: Dell™ Latitude™ CS/CSx Portable Computers User's Guide

- [External Media Bay](#)
 - [CD-ROM and DVD-ROM Drives](#)
 - [Diskette Drive](#)
-

[Back to Contents Page](#)

PC Cards: Dell™ Latitude™ CS/CSx Portable Computers User's Guide

[About PC Cards](#)

[Removing PC Cards](#)

[Installing PC Cards](#)

[Configuring PC Cards](#)

About PC Cards

The computer provides two slots in which you can install PC Cards that comply with Release 2.01 of the Personal Computer Memory Card International Association (PCMCIA) standard and Release 4.2 of the Japanese Electronic Industry Development Association (JEIDA) standard.

The computer supports type I, type II, and type III PC Cards, such as modems, local area network (LAN) cards, wireless LAN cards, and small computer system interface (SCSI) cards. Also supported are such memory devices as static random-access memory (SRAM) cards that emulate diskettes, random-access memory (RAM) cards, and one-time programmable (OTP) ROM cards, and advanced technology attachment (ATA) cards that emulate integrated drive electronics (IDE) hard-disk drives.

If you are using the Microsoft® Windows® 95 or Windows 98 operating system, you can use a zoomed video (ZV) PC Card, such as a hardware Moving Picture Experts Group (MPEG) decoder. ZV cards must be used only in the upper PC Card slot. (The Microsoft Windows NT® 4.0 operating system does not support ZV.)

 *NOTES: A PC Card is not a boot device.*

The "type" of a card refers to its thickness, not its functionality.

Your computer recognizes most I/O cards and automatically loads the device driver associated with that card.

NOTICE: Take extra precautions if you use extended PC Cards in your computer. Extended cards are longer versions of standard PC Cards. They fit into, and operate correctly with, your computer. However, they extend beyond the edge of the computer when installed. If something strikes the exposed end of an installed card, your system board can be damaged. Because of space considerations, you may have trouble using two PC Cards in your computer if one of them is an extended card. It may be easier to use an extended card if you install it in the upper PC Card slot. Always remove an extended PC Card before you pack the computer in its carrying case.

You can use the following PC Card combinations in the PC Card slots:

- 1 A single type I or type II card (using either the upper or lower PC Card slot)
- 1 A single type III card (using the lower PC Card slot only)
- 1 One type I card and one type II card (using either slot)
- 1 Two type I cards or two type II cards

 *Note: Use a ZV PC Card in the upper slot only.*

Installing PC Cards

PC Cards are generally marked with a symbol, such as a triangle or an arrow, to indicate which end should be inserted into the slot. The cards are keyed to prevent incorrect insertion. If card orientation is not clear, see the documentation that came with the card.

You do not need to turn off your computer or exit suspend or standby mode before you install a PC Card. To install a PC Card (see Figure 1), perform the following steps.

Figure 1. Installing a PC Card

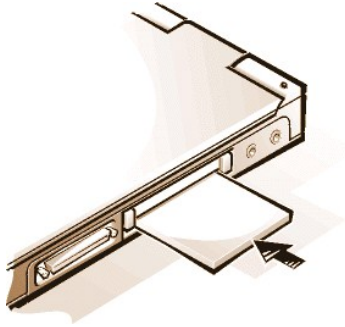

1. If necessary, remove the blank from the PC Card slot you intend to use. Press the eject button once to pop the button out, press it again to eject the blank partway, and then pull the blank out.
2. Make sure that the eject button is pressed all the way in. Hold the card with its orientation symbol pointing into the slot and the top side of the card facing up.
3. Insert the card into the slot and press in firmly until the card is completely seated in the internal PC Card connector.
4. If you encounter too much resistance when inserting it, do not force the card. Check the card's orientation and try again.

PC Card Blanks

Save the blank to use whenever you do not have a PC Card installed. The blank protects the PC Card slot from dust and other particles.

Removing PC Cards

NOTICE: If you are using Windows 95 or Windows 98, use the PC Card configuration utility on the taskbar to select and stop a card before you remove it. If you do not remove the card in the configuration utility, you could lose data from open application programs.

To remove a PC Card (see Figure 2), perform the following steps.

Figure 2. Removing a PC Card

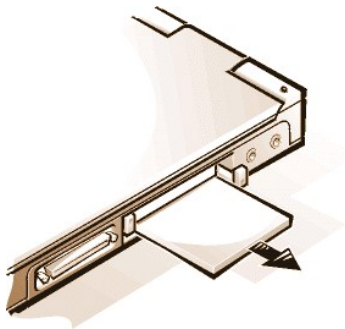

1. Press the PC Card eject button once to pop the button out, and then press the button in again to eject the card partway. (The button may or may not pop out again when you eject the card.)
2. Gently remove the card.

To protect the PC Card slots, install a blank if you are not going to use the slots.

Configuring PC Cards

The PC Card configuration utility performs the following functions:

1. Notifies you whenever a PC Card is inserted and tells you how the card is configured
1. Automatically loads the proper device driver if it is available on the hard-disk drive
1. If drivers are not available on the hard-disk drive, prompts you to install them by using the device driver diskette that came with the card

The operating system automatically detects a PC Card and opens the **Add New Hardware** menu from the **Control Panel**. For information, see the PC Card operating system documentation.

[Back to Contents Page](#)

[Back to Contents Page](#)

Powering Your Computer: Dell™ Latitude™ CS/CSx Portable Computers User's Guide

- [AC Adapter](#)
 - [Power Management Settings](#)
 - [Batteries](#)
-

[Back to Contents Page](#)

[Back to Contents Page](#)

Preface: Dell™ Latitude™ CS/CSx Portable Computers User's Guide

[About This Guide](#)

[Notational Conventions](#)

[Warranty and Return Policy Information](#)

[Typographical Conventions](#)

[Other Documents You May Need](#)

About This Guide

This guide is intended for anyone who uses the Dell Latitude CS/CSx portable computers. It can be used by both first-time and experienced computer users who want to learn about the features of the computer. This guide also provides basic troubleshooting procedures and instructions for using the Dell Diagnostics to test your computer and its components. The sections are summarized as follows:

- 1 ["Introduction"](#) — overview of the computer features and available upgrades
- 1 ["Setup and Operation"](#) — instructions on operating your computer
- 1 ["Powering Your Computer"](#) — instructions and options on how to power your computer
- 1 ["Traveling With Your Computer"](#) — suggestions on how to travel safely with your computer
- 1 ["Drivers"](#) — instructions on how to install driver software on your computer
- 1 ["Customizing Your Computer"](#) — instructions on accessing the System Setup program, power management software, and the Suspend-to-Disk utility, all of which allow you to change system settings affecting your computer's power conservation features
- 1 ["Removing and Replacing Parts"](#) — instructions on how to remove and install hard-disk drives and memory modules
- 1 ["Troubleshooting Your Computer"](#) — initial checks and procedures that can be used to solve basic computer problems, general guidelines on analyzing software problems, messages, and beep codes
- 1 ["Technical Specifications"](#) — reference material about the details of your computer
- 1 ["Getting Help"](#) — help tools Dell provides to assist you if you have a problem with the computer and explains how and when to call Dell for technical assistance.

Warranty and Return Policy Information

Dell Computer Corporation ("Dell") manufactures its hardware products from parts and components that are new or equivalent to new in accordance with industry-standard practices.

For information about the Dell warranty and return policy, see your Dell Latitude *System Information* guide.

Other Documents You May Need

Besides this *User's Guide*, the following documentation is included with your computer.

 **NOTE:** Documentation updates are sometimes included with your computer to describe changes to your computer or software. Always read these updates **before** consulting any other documentation because the updates contain the latest information.

- 1 The operating system *Setup Guide*, which describes how to set up the Dell-installed operating system on your computer.
 - 1 Microsoft® Windows 95®, Windows 98, and Windows NT® operating system documentation is included if you ordered your operating system from Dell. This documentation describes how to configure and use your operating system software.
 - 1 Documentation is included with any options you purchase separately from your computer. This documentation includes information that you need to configure and install these options in your Dell computer.
 - 1 "Readme" files may be installed on your hard-disk drive to provide last-minute updates about technical changes to your computer or advanced technical reference material intended for experienced users or technicians.
-

Notational Conventions

The following subsections list notational conventions used in this document.

Notes, Notices, and Cautions

Throughout this guide, blocks of text may be accompanied by an icon and printed in bold type or in italic type. These blocks are notes, cautions, and warnings, and they are used as follows:

 **NOTE:** A NOTE indicates important information that helps you make better use of your computer.

NOTICE: A NOTICE indicates either potential damage to hardware or loss of data and tells you how to avoid the problem.

 **CAUTION:** A CAUTION indicates the potential for bodily harm and tells you how to avoid the problem.

Typographical Conventions

The following list defines (where appropriate) and illustrates typographical conventions used as visual cues for specific elements of text throughout this document:

- 1 *Interface components* are window titles, button and icon names, menu names and selections, and other options that appear on the monitor screen or display. They are presented in bold.

Example: Click **OK**.

- 1 *Keycaps*, the labeling that appears on the keys on a keyboard, are enclosed in angle brackets.

Example: <Enter>

- 1 *Key combinations* are series of keys to be pressed simultaneously (unless otherwise indicated) to perform a single function.

Example: <Ctrl><Alt><Enter>

- 1 *Commands* presented in lowercase bold are for reference purposes only and are not intended to be typed at that particular point in the discussion.

Example: "Use the **setup** command to . . ."

In contrast, commands presented in the Courier New font are intended to be typed as part of an instruction.

Example: "Type `format a:` to format the diskette in drive A."

- 1 *Filenames* and *directory names* are presented in lowercase bold.

Examples: **autoexec.bat** and **c:\windows**

- 1 *Syntax lines* consist of a command and all its possible parameters. Commands are displayed in lowercase bold; variable parameters (those for which you substitute a value) are displayed in lowercase italics; constant parameters are displayed in lowercase bold. The brackets indicate items that are optional.

Example: **del** [*drive:*][*[[path]filename]*] [*/p*]

- 1 *Command lines* consist of a command and may include one or more of the command's possible parameters. Command lines are presented in the Courier New font.

Example: `del c:\myfile.doc`

- 1 *Screen text* is text that appears on the screen of your display or external monitor. It can be a system message, for example, or it can be text that you are instructed to type as part of a command (referred to as a *command line*). Screen text is presented in the Courier New font.

Example: The following message appears on your screen:

`No boot device available`

- 1 *Variables* are symbols for which you substitute a value. They are presented in italics.

Example: module *n* (where *n* represents the memory module number)

Removing and Replacing Parts: Dell™ Latitude™ CS/CSx Portable Computers User's Guide

[Replacing a Primary Hard-Disk Drive](#)

[Installing a Memory Module](#)

Replacing a Primary Hard-Disk Drive

NOTICE: To prevent data loss, turn off your computer before you remove the hard-disk drive. Do not remove the hard-disk drive if the computer is in suspend (or standby) mode or if the drive access indicator is lit. Removing the drive under these conditions will lead to loss of data.

NOTICE: Hard-disk drives are extremely fragile and must be handled carefully to avoid damage. Follow these guidelines:

- 1 The primary hard-disk drive is installed in a metal carrier to protect the drive and make installation easier. When you remove and install hard-disk drives, handle the drive carrier, not the drive itself.
- 1 Never press down on the top of the drive.
- 1 Do not drop the drive. Even a slight jar or bump can damage the drive heads and spinning plates, thus rendering the drive inoperable.

! **CAUTION:** The primary hard-disk drive may be hot to the touch under extreme environmental conditions. If the drive is hot, allow it to cool before you replace it.

To replace a primary hard-disk drive, perform the following steps:

1. Save any open files, turn off the computer, and remove any installed batteries.

NOTICE: To avoid scratching the top of the computer, make sure that your work surface is clean. You may want to put down a protective mat before turning over the computer.

2. Remove the old hard-disk drive from the drive bay.

Close the display and turn the computer over. Using a #0 (very small) Phillips-head screwdriver, remove the two screws in the hard-disk drive door (see Figure 1). Save the screws for use later in this procedure.

With the computer still upside-down, press upward on the hard-disk drive door until it feels loose; then grasp the door and pull it and the drive straight out from the side of the computer.

When the hard-disk drive is not in the computer, protect the drive from exposure to static electricity.

Figure 1. Removing a Hard-Disk Drive

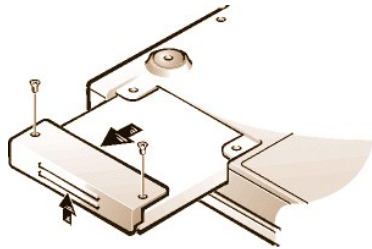

3. Remove the new hard-disk drive assembly from its packaging.

Save the original packaging to use when you store or ship the hard-disk drive.

NOTICE: If the hard-disk drive assembly does not slide in easily, pull it out and try again. To avoid damage, do not force the drive assembly into the bay.

4. Install the new hard-disk drive in the computer.

Insert the drive, connector first and label facing down, into the drive bay. Holding the drive door up slightly, push the drive all the way into the

bay. Then press down and in on the drive door until it snaps into position, flush with the computer case.

5. Replace the screws you removed in step 2. Be careful not to overtighten the screws.

If you have installed a new hard-disk drive, follow the directions that came with the drive to partition and logically format the drive and to create an S2D partition.

Preparing a New Primary Drive

Every primary hard-disk drive must be physically formatted, partitioned, and logically formatted before it can be used to store data. Every primary hard-disk drive from Dell is physically formatted before it is sent to you. Use the program(s) provided by your operating system to partition and logically format the hard-disk drive. For more information, see both your operating system and your drive documentation.

Installing Memory Modules

Your system's factory-installed memory can range from 64 megabytes (MB) to a system maximum of 320 MB. Depending on the memory already installed, you may be able to increase memory by installing a 32-, 64-, or 128-MB synchronous dynamic random-access memory (SDRAM) small-outline dual-inline memory modules (SODIMMs) in the memory upgrade socket. The maximum achievable memory for your system depends on the system's original memory configuration.

 **NOTE:** If necessary, print these instructions for reference before proceeding.

NOTICE: Dell Latitude CS/CSx portable computers support only SDRAM SODIMMs. Extended-data out (EDO) memory modules are not supported.

To upgrade computer memory, you can install or replace a memory module through the memory module cover on the underside of the computer. To prepare the computer for the removal or installation of a memory module, perform the following steps.

NOTICE: Ground yourself by touching an unpainted metal surface of a connector on the back of the computer. While you work, periodically touch the connector to dissipate any static electricity that might harm internal components.

1. Turn off the computer and any attached devices.

Do not install memory modules while the computer is in suspend, standby, or suspend-to-disk mode.

2. If the computer is docked, undock it.
3. Disconnect the computer and peripherals from their electrical outlets to reduce the potential for personal injury or shock.
4. Disconnect any telephone or telecommunication lines from the computer.
5. Remove the battery from the battery bay.

To remove or install a memory module, perform the following steps.

NOTICE: To avoid scratching the top of the computer, make sure that your work surface is clean. You may want to put down a protective mat before turning over the computer.

1. Close the display, turn the computer upside down, and remove the memory module cover (see Figure 2).

Use a #1 Phillips-head screwdriver to remove the two screws securing the memory module cover. When the memory module cover pops up slightly, lift it up and remove it to expose the memory socket or installed memory module beneath.

Figure 2. Removing the Memory Module Cover

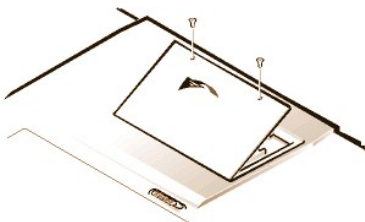

2. If you are replacing a memory module, remove the old one.

Carefully spread apart the inner metal tabs of the memory module socket just far enough for the memory module to disengage from the socket (it should pop up slightly). Then lift the memory module away from the socket (see Figure 3).

Figure 3. Removing a Memory Module

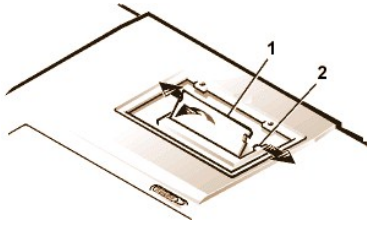

- 1 Memory module
- 2 Metal tabs (2)

3. Ground yourself and unpack the new memory module from the upgrade kit.
4. Install the new memory module in the socket (see Figure 4).

Figure 4. Installing a Memory Module

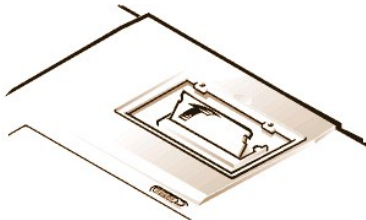

Memory modules are *keyed*, or designed to fit into their sockets in only one direction. The socket is notched so that the memory module can be seated only one way as follows:

- a. Align the memory module's edge connector with the slot in the center of the memory module socket.
- b. With the module at a 45-degree angle, press the memory module's edge connector firmly into the memory module socket.
- c. Pivot the memory module down until it clicks into place.

If you do not hear a click as each end of the memory module snaps into the metal tabs, remove the memory module and reinstall it.

5. Replace the memory module cover as follows:
 - a. Set the memory module cover into the opening, aligning the tabs on one side with the slots in the computer cover.
 - b. Press the cover down and replace the screws you removed in step 1.

NOTICE: After installation, if the memory module cover does not fit or is difficult to close, you may have installed the memory module improperly. Remove the module and reinstall it. Do not force the memory module cover to close because you may damage your computer.

6. Reconnect your computer and devices to their electrical outlets and turn them on.

As the computer boots, it detects the presence of additional memory and automatically updates the system configuration information.

7. In one of the following ways, verify that the [System Memory](#) option in the System Setup program reflects the newly installed memory:
 - 1 Click the **Start** button, point to **Settings**, click **Control Panel**, and click the **System** icon. The amount of memory installed in the computer is displayed in the lower-right corner of the **General** tab window.
 - 1 In the System Setup program, the **System Memory** option appears in the lower-right corner of pages 1, 2, and 4.

If the system memory total is incorrect, the memory module(s) may not be installed properly. Repeat [preparatory steps](#) 1 through 5 and [removal and installation steps](#) 1 through 7 until the memory total is correct.

8. Run the **System Memory** test of the [Dell Diagnostics](#) to confirm that all installed memory modules are operating correctly.
9. Use the [Suspend-to-Disk utility](#) to update the S2D partition on your hard-disk drive. The S2D partition stores system data while the computer is in S2D mode.

Suspend-to-Disk Utility: Dell™ Latitude™ CS/CSx Portable Computers User's Guide

 [Suspend-to-Disk Utility](#)

 [Removing the S2D Partition](#)

 [Creating the S2D Partition](#)

Suspend-to-Disk Utility

The Suspend-to-Disk (S2D) utility allows you to manage the S2D partition in your file system as your computing needs change. For instance, you can remove the S2D partition if you need the space on the hard-disk drive for other purposes, or you can use the S2D utility to create the partition if you have removed it.

Removing the S2D Partition

If you want to use the S2D partition on your hard-disk drive for another purpose (for instance, if you are running out of file space), perform the following steps to remove the partition:

1. At an MS-DOS® prompt, type `cd c:\dell\util` and press <Enter> to change to the directory on your hard-disk drive that contains the S2D utility files.

If you are using an operating system that is not compatible with MS-DOS, see the **readme.s2d** file for instructions.

2. Type `rms2d` and press <Enter>.

Status messages appear on the display as the removal process progresses. When the S2D partition has been removed, the following message appears:

```
The S2D partition was successfully removed.
```



NOTE: After you remove the S2D partition, the computer cannot enter S2D mode until you recreate the partition. If you try to enter S2D mode and receive the message *No Suspend-To-Disk partition available*, you must create an S2D partition.

Creating the S2D Partition

The **mks2d.exe** file creates the S2D partition the computer uses to store the system data that is saved when you put the computer in S2D mode. Use the **mks2d.exe** file to create a new S2D partition in the following cases:

- 1 If Dell did not install MS-DOS on your hard-disk drive
- 1 If you increase the amount of system memory by adding a memory module
- 1 If you used the **rms2d.exe** file to remove the original S2D partition and now want to recreate the partition
- 1 If your hard-disk drive becomes corrupted
- 1 If you install a new hard-disk drive
- 1 If you received the system utilities separately on diskette or if you deleted the S2D utility from your hard-disk drive

To create an S2D partition, perform the following steps.



NOTE: If you are creating the partition on a new hard-disk drive, if Dell did not install MS-DOS on your hard-disk drive, or if you are using an operating system that is not compatible with MS-DOS, read the **readme.s2d** file before performing the following procedure.

1. At an MS-DOS prompt, type `cd c:\dell\util` and press <Enter> to change to the directory on your hard-disk drive that contains the S2D utility files.
2. Type `mks2d` and press <Enter>.

As the utility builds the partition, status messages appear on the display. If an error message appears, it provides information about which steps to take to continue building the partition.

When the S2D partition has been built and verified, the following message appears:

The S2D partition was successfully created.

[Back to Contents Page](#)

[Back to Contents Page](#)

Securing Your Computer: Dell™ Latitude™ CS/CSx Portable Computers User's Guide

[About Passwords](#)

[Using a Hard-Disk Drive Password](#)

[Using a Primary Password](#)

[Physically Securing the Computer](#)

[Using an Administrator Password](#)

[Asset Tag Utility](#)

About Passwords

A primary password prevents unauthorized access to the computer at start-up. An administrator password can be used in place of the primary password. A hard-disk drive password helps prevent the unauthorized access of data on the hard-disk drive, even when the device is placed into another computer.

 **NOTES:** All three passwords are disabled when you receive your computer. You need to assign those passwords if you require password security for your computer. Some companies may assign any or all of these passwords before distributing the computer.

Use the [System Setup program](#) to assign all passwords.

NOTICE: The password features provide a high level of security for the data in your computer or hard-disk drive. However, they are not foolproof. If your data requires more security, you should obtain and use additional forms of protection, such as data encryption programs or PC Cards with encryption features.

If you forget any of your passwords, [call Dell](#). For your protection, Dell's technical support staff will ask you for proof of your identity to make sure that an unauthorized person is not trying to use the computer.

Using a Primary Password

The primary password allows you to protect the computer from unauthorized access.

After assigning a primary password, you must enter it each time you turn on your computer. The following message appears at the bottom of the screen each time you turn on the computer:

```
Please type in the primary or administrator password and press <Enter>.
```

To continue, type your password and press <Enter>.

 **NOTE:** If no password is entered within 2 minutes, the computer returns to its previous state.

If you have assigned an administrator password, you can use it instead of the primary password. The computer does not specifically prompt you for the administrator password.

NOTICE: If you disable the administrator password, the primary password is also disabled.

Using an Administrator Password

The administrator password is designed to give system administrators or service technicians in large companies access to computers for repair or reconfiguration. The administrators or technicians can assign identical administrator passwords to groups of computers as they are unpacked and configured, leaving the primary password free to be assigned by the user.

When you set an administrator password, the [Configure Setup](#) option becomes available in the System Setup program. The **Configure Setup** option allows you to restrict access to the System Setup program in the same way a system password restricts access to the system.

The administrator password can be used in place of the primary password. Whenever you are prompted to enter the primary password, you can enter the administrator password instead.

 **NOTE:** The administrator password provides access to the system, but it does not provide access to the hard-disk drive when it is protected by a password.

If you forget the primary password and do not have an administrator password assigned, or if you have both a primary and an administrator password assigned but forget them both, [call Dell](#).

NOTICE: If you disable the administrator password, the primary password is also disabled.

Using a Hard-Disk Drive Password

The hard-disk drive password helps protect the data on your hard-disk drive from unauthorized access. You can also assign a password for the modular hard-disk drive (if one is being used) that can be the same as or different from the password for the primary hard-disk drive.

 **NOTE:** Hard-disk drives that are not purchased from Dell for use with Latitude C-Family computers may not support the hard-disk drive password option.

After assigning a hard-disk drive password, you must enter it each time you turn on the computer and each time you resume normal operation from suspend mode or standby mode.

If the hard-disk drive password is enabled, the following message appears at the bottom of the screen each time you turn on the computer:

```
Please type in the hard-disk drive password and press <Enter>.
```

To continue, enter the hard-disk drive password. Press <Esc> to return the computer to its previous state—suspend, standby, or off.

 **NOTE:** If no password is entered within 2 minutes, the computer returns to its previous state.

If you enter the wrong password, the following message appears:

```
Invalid password  
[Press Enter to retry]
```

If the correct password is not entered in three attempts, you receive a message stating that the hard-disk drive cannot be found. If the hard-disk drive is inaccessible and the [boot options](#) in the System Setup program are set to allow booting from another device, the computer tries to boot from another device. If all boot attempts are unsuccessful, the computer prompts you to enter the System Setup program and modify the boot options.

 **NOTES:** If the hard-disk drive password, the modular hard-disk drive password, and the primary password are the same, you are prompted only for the primary password. If the hard-disk drive password is different from the primary password, you are prompted for both. Two different passwords provide greater security.

The administrator password provides access to the system, but it does not provide access to the hard-disk drive when it is protected by a password.

Physically Securing the Computer

To prevent unauthorized removal of the computer, you can use a security cable to attach the computer to an immovable object. Your computer has a security cable slot located on the left side of the computer near the back ([see Figure 1](#)).

Description of Security Cable Slots

The security cable slot allows you to attach a commercially available antitheft device to the computer. Antitheft devices for portable computers usually include a segment of metal-stranded cable with an attached locking device and associated key. You can use a security cable on your computer when it is undocked and also when it is docked in a Dell Latitude C/Port Family Advanced Port Replicator (C/Port APR) or a C/Dock Family Expansion Station.

Basic Instructions for Using Security Cable Slots

To prevent unauthorized removal of your computer, loop the cable around an immovable object, insert the locking device into either of the security cable slots, and lock the device. See [Figure 1](#) for an example of how to secure your computer. Complete instructions for installing this kind of antitheft device are usually included with the device.

Figure 1. Securing the Computer

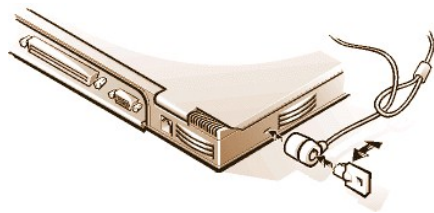

 **NOTE:** Antitheft devices are of differing designs. Before purchasing such a device, make sure that it will work with the security cable slot in your computer.

Asset Tag Utility

Dell has installed the Asset Tag utility on your computer. The Asset Tag utility allows you to perform the following actions:

- 1 View the computer's service tag

The non-modifiable service tag, which is viewable in the System Setup program, is set by Dell at the factory. It is used to identify your computer to Dell for service and warranty purposes.

- 1 Set, view, and modify the computer's asset tag

The asset tag, which can be set by you or your company, is optional and is not required or used by Dell. The asset tag can be used in any way desired; typically it is used by a company to differentiate and identify multiple computers that use an internally assigned identifier.

- 1 Set, view and modify the computer's owner tag

The owner tag, which can be set by you or your company, is optional and is not required or used by Dell. It can be used in any way desired. Typically, it is used by a company to identify the computer as belonging to the company; it might contain a telephone number that can be used to help return a unit to its owner. This tag is displayed on the system log-on screen and on the screens that prompt for the primary and hard-disk drive passwords.

Viewing Existing Asset, Service, and Owner Tags

To view existing asset, service, and owner tags, perform the following steps:

1. Click the **Start** button, point to **Programs**, and click **MS-DOS Prompt**.
2. Type `cd c:\Dell\Util` and press <Enter>.
3. Type `asset` and press <Enter>.

Assigning an Asset Tag

An asset tag can have up to ten characters; any combination of characters is valid except those that begin with a forward slash (/) or a question mark (?). Spaces count as characters. To assign or change an asset tag, perform the following steps:

1. Click the **Start** button, point to **Programs**, and click **MS-DOS Prompt**.
2. Type `cd c:\Dell\Util` and press <Enter>.
3. Type `asset` and a space followed by the new tag, and press <Enter>.

For example, type the following command line and press <Enter>:

```
asset 1234 $AB&C
```

4. When the computer prompts you to verify that you want to change the asset tag, type `y` and press <Enter>.

The computer displays the new or modified asset tag and the service tag.

 **NOTE:** For security reasons, you cannot set, change, or delete the asset tag if either the primary or the administrator password is set.

Deleting an Asset Tag

To delete the asset tag without assigning a new one, perform the following steps:

1. Click the **Start** button, point to **Programs**, and click **MS-DOS Prompt**.
2. Type `cd c:\Dell\Util` and press <Enter>.
3. Type `asset /d` and press <Enter>.

Assigning an Owner Tag

An owner tag can have up to 48 characters, including spaces. Any combination of characters is valid except those that begin with a forward slash (/) or a question mark (?). To assign an owner tag, perform the following steps:

1. Click the **Start** button, point to **Programs**, and click **MS-DOS Prompt**.
2. Type `cd c:\Dell\Util` and press <Enter>.
3. Type `asset /o` and a space followed by the new owner tag, and press <Enter>.

For example, type the following command line and press <Enter>:

```
asset /o ABC Company
```

4. When the computer prompts you to verify that you want to change the owner tag, type `y` and press <Enter>.

The computer displays the new owner tag.

Deleting an Owner Tag

To delete the owner tag without assigning a new one, perform the following steps:

1. Click the **Start** button, point to **Programs**, and click **MS-DOS Prompt**.
2. Type `cd c:\Dell\Util` and press <Enter>.
3. Type `asset /o /d` and press <Enter>.

 **NOTE:** For security reasons, you cannot set, change, or delete the owner tag if either the primary or the administrator password is set.

[Table 1](#) lists the command-line options you can use with the Asset Tag utility. To use one of these options, open an MS-DOS® prompt, type `asset` and a space followed by the option, and then press <Enter>.

Table 1. Asset Tag Utility Commands

Asset Tag Command	Function
<code>asset</code>	Displays the asset, service, and owner tags
<code>asset <tag></code>	Sets a new asset tag
<code>asset /d</code>	Deletes the asset tag
<code>asset /o <tag></code>	Sets a new owner tag
<code>asset /o /d</code>	Deletes the owner tag
<code>asset /?</code>	Displays the Asset Tag utility help screen

[Back to Contents Page](#)

[Back to Contents Page](#)

Using the System Setup Program: Dell™ Latitude™ CS/CSx Portable Computers User's Guide

- [Overview](#)
 - [Entering the System Setup Program](#)
 - [Using the System Setup Program](#)
-

Overview

Each time you turn on your computer, it compares the installed hardware with the system configuration information stored in nonvolatile random-access memory (NVRAM). If the system detects a discrepancy, it generates an error message for each incorrect configuration setting. You can use the System Setup program to adjust the configuration settings.

You can use the System Setup program as follows:

- 1 To set or change user-selectable features — for example, your password or power management features
- 1 To verify information about your computer's current configuration, such as the amount of system memory

For some setup options, you must reboot the computer before any changes take effect. Changes for other options take effect immediately.

 **NOTE:** If you change an option that is activated by rebooting, the System Setup program displays the setting you selected rather than the setting currently in effect. You **must** reboot for the new setting to take effect.

After you set up your computer, run the System Setup program to familiarize yourself with your system configuration information and optional settings. Dell recommends that you write down the information for future reference.

 **NOTES:** If the computer uses the Microsoft® Windows® 95 operating system, you can also use the Dell Control Center to view and change the system configuration. Access the Dell Control Center from the **Dell Accessories** folder.

If the computer uses the Microsoft Windows NT® 4.0 or Windows 98 operating system, you must use the System Setup program to view and change your system configuration.

For more information, see "[System Setup Options](#)."

Entering the System Setup Program

To enter the System Setup program, press <Fn><F1> at any time on the computer keyboard (or press <Scroll Lock><F1> on an external keyboard if the [External Hot Key](#) option is enabled). To open the System Setup program directly to the [Battery Status](#) screen, press <Fn><F3> on the computer keyboard (or press <Scroll Lock><F3> on an external keyboard if the **External Hot Key** option is enabled).

To exit the System Setup program, press <Esc>. If you change the setting of an option that requires rebooting to take effect, exit the operating system *before* rebooting. (The **Help** text in the upper-right corner of System Setup screens 1, 2, and 4 tells you if the computer must be rebooted.)

 **NOTE:** If the System Setup program is running when the computer enters suspend mode, the computer exits the System Setup program and then enters suspend mode.

For more information, see "[System Setup Options](#)."

Using the System Setup Program

The System Setup screens display the current setup and configuration information and optional settings for your computer. Information on the screens is organized in five boxed areas:

- 1 **Title**

The box at the top of all screens lists the page number, system name, and version number of the basic input/output system (BIOS).
- 1 **Options**

The box on the left half of screens 1, 2, and 4 lists options that define the installed hardware in your computer and the power conservation

and security features for your computer.

Fields next to the options contain settings or values. You can change those values that appear white on the screen. Options or values that you cannot change (because they are determined or calculated by the computer) appear dimmed or blue, depending on your display.

1 **Help**

The box on the upper-right half of screens 1, 2, and 4 displays help information for the option with a currently highlighted field.

1 **Computer data**

The box in the lower-right corner of screens 1, 2, and 4 displays information about your computer.

1 **Key functions**

The line of boxes across the bottom of all screens lists keys and their functions within the System Setup program.

For more information, see "[System Setup Options](#)."

[Back to Contents Page](#)

[Back to Contents Page](#)

System Setup Options: Dell™ Latitude™ CS/CSx Portable Computers User's Guide

AC	Disk Time-Out	Parallel Mode
Admin Password	Diskette Drive A	Pointing Device
Alarm Resume	Diskette Drive B	Power Management
Asset Tag	Diskette Reconfig	Primary Hard Drive
Audio Mode	Display Close	Primary Password
Battery	Display Time-out	Ring/Event Resume
Battery Status	Docking Ethernet	S2D Time-out
BIOS Version	Docking IRQ	Serial Port
Boot First Device	Docking Status	Service Tag
Boot Second Device	External Hot Key	Smart CPU Mode
Boot Third Device	External Media Bay	Suspend Time-out
Boot Speed	Infrared Data Port	System Memory
Brightness	Infrared Mode	System Primary
Click Volume	Internal Cache	Time
Configure Setup	Keyboard Click	Universal Connect
Date	Microprocessor	Video Memory

AC

AC, an option under **Power Management**, allows you to set different time-outs for the following options when you operate your computer from AC power: **Display Time-out**, **Disk Time-out**, **Suspend Time-out**, **S2D Time-out**, **Smart CPU Mode**, and **Brightness**.

A change to the **AC** option takes effect immediately (rebooting is not required).

Admin Password

Admin Password displays the current status of your administrator password and allows you to assign or change this password. Settings for this option are:

- 1 **Disabled** (the default) — Indicates that no administrator password is assigned
- 1 **Enabled** — Indicates that an administrator password is currently assigned

The administrator password is designed for use by system administrators and service technicians in corporate environments. If an administrator password is assigned, you can use it to access the computer even if you do not know the primary password.

NOTICE: The password features provide a high level of security for the data in your computer. However, they are not foolproof. If your data requires more security, you should obtain and use additional forms of protection, such as data encryption programs or PC Cards with encryption features.

Alarm Resume

Alarm Resume directs the computer to resume normal operation when it is in suspend mode and detects an alarm from the real-time clock (RTC). Such alarms can be set through various application programs. For the alarms in these programs to work, **Alarm Resume** must be set to **Enabled**.

Settings for this option are:

- 1 **Enabled** (the default) — Resumes normal operation when the computer detects an alarm
- 1 **Disabled** — Keeps the computer in suspend mode even if the computer detects an alarm

A change to **Alarm Resume** takes effect immediately (rebooting is not required).

Asset Tag

Asset Tag displays the asset tag code if you or your organization assigned one to your computer.

For more information, see "[Asset Tag Utility](#)."

Audio Mode

Audio Mode manages the audio resources of the computer and the external devices you use with it. This option is set to **Full Duplex**, which allows the computer's audio system to play and record sounds simultaneously. No user-selectable settings are available for this option.

Battery

Battery, an option under **Power Management**, allows you to set different time-outs for the following options when you operate your computer from battery power: **Display Time-out**, **Disk Time-out**, **Suspend Time-out**, **S2D Time-out**, **Smart CPU Mode**, and **Brightness**.

A change to **Battery** takes effect immediately (rebooting is not required).

Battery Status

Battery Status (page 3 of the System Setup screens) is a graphical representation of the approximate amount of charge left in the battery. No user-selectable settings are available for this option. If a battery is not installed, the battery gauge illustration indicates **Battery Status: Not Installed**.

If you are not in the System Setup program, you can see the battery gauge illustration at any time by pressing <Fn><F3>.

BIOS Version

BIOS Version displays the version number and release date of the basic input/output system (BIOS) in your computer. A service technician may ask you for this version number if you call Dell for technical assistance.



NOTE: Dell may periodically offer revisions of the BIOS that add features or solve specific problems. Because the BIOS for your computer is stored on a reprogrammable flash-memory chip, you can use the Flash BIOS Update program to update your computer's BIOS entirely through software.

Boot First Device

Boot First device determines which disk device your computer uses to find the software needed to start the operating system.

The term *boot* refers to the computer's start-up procedure. When you turn on the computer, it "bootstraps" itself into an operational state by loading into memory a small program, which in turn loads the necessary operating system. **Boot First device** tells the computer where to look first for the files that it needs to load.

Settings for this option are:

- 1 **Diskette Drive** (the default) — Causes your computer to attempt first to boot from a bootable diskette
- 1 **Internal HDD** — Causes your computer to attempt first to boot from the hard-disk drive
- 1 **CD-ROM/DVD-ROM Drive** — Causes your computer to attempt first to boot from a bootable CD
- 1 **Ext Media Bay HDD** — Causes your computer to attempt first to boot from the second hard-disk drive installed in the external media bay
- 1 **PCI Slot NIC** — Causes your computer to attempt first to boot from a network interface controller (NIC) PC Card

- 1 **Dock II/Port II NIC** — Causes your computer to attempt first to boot from a NIC card installed in the C/Port Family APR or C/Dock Family Expansion Station
- 1 **None**

For a change to **Boot First device** to take effect, you must reboot your computer.

Boot Second Device

If the computer cannot find the software it needs to start the operating system on the drive identified in **Boot First device**, it will search the device named in **Boot Second device**.

Settings for the option are:

- 1 **Internal HDD** (the default) — Causes your computer to attempt to boot from the hard-disk drive
- 1 **Diskette Drive** — Causes your computer to attempt to boot from the diskette drive
- 1 **CD-ROM/DVD-ROM Drive** — Causes your computer to attempt to boot from a bootable CD
- 1 **Ext Media Bay HDD** — Causes your computer to attempt to boot from the second hard-disk drive installed in the external media bay
- 1 **PCI Slot NIC** — Causes your computer to attempt to boot from a NIC PC Card
- 1 **Dock II/Port II NIC** — Causes your computer to attempt to boot from a NIC card installed in the C/Port Family APR or C/Dock Family Expansion Station
- 1 **None**

For a change to **Boot Second device** to take effect, you must reboot your computer.

Boot Third Device

If the computer cannot find the software it needs to start the operating system on the drive identified in **Boot Second device**, it will search the device named in **Boot Third device**.

Settings for the option are:

- 1 **None** (the default)
- 1 **Internal HDD** — Causes your computer to attempt to boot from the hard-disk drive
- 1 **Diskette Drive** — Causes your computer to attempt to boot from the diskette drive
- 1 **CD-ROM/DVD-ROM Drive** — Causes your computer to attempt to boot from a bootable CD
- 1 **Ext Media Bay HDD** — Causes your computer to attempt to boot from the second hard-disk drive installed in the external media bay
- 1 **PCI Slot NIC** — Causes your computer to attempt to boot from a NIC PC Card
- 1 **Dock II/Port II NIC** — Causes your computer to attempt to boot from a NIC card installed in the C/Port Family APR or C/Dock Family Expansion Station

For a change to **Boot Third device** to take effect, you must reboot your computer.

Boot Speed

Boot Speed allows you to choose between the computer's processing speed (the default) and **Compatible**, a slower compatibility speed. The compatibility speed varies, depending on the configuration of your computer.

When you change the setting of **Boot Speed**, the System Setup program stores and continues to display the new setting even if you do not reboot your computer when you exit the System Setup program. If you start the System Setup program again during your current work session, the processing speed displayed for **Boot Speed** may not match the actual speed at which your computer is running.

For a change to **Boot Speed** to take effect, you must reboot your computer.

Brightness

Brightness allows you to specify the brightness of the display when the computer is operating on battery power. Use the left- and right-arrow keys to change the brightness of the display. When the computer is powered by a battery, the default is **Minimum**. If the computer is using AC power, the default is **Maximum**.

A change to **Brightness** takes effect immediately (rebooting is not required).

Click Volume

Click Volume allows you to disable or adjust the volume of the keyboard clicks if **Keyboard Click** is enabled. The default is **Maximum**.

A change to **Click Volume** takes effect immediately (rebooting is not required).

Configure Setup

Configure Setup allows you to restrict access to the System Setup program in the same way a system password restricts access to the system. Only available when you set the administrator password.

Date

Date resets the date on the computer's internal calendar.

Your computer automatically displays the day of the week corresponding to the settings in the three fields that follow (**month**, **day-of-the-month**, and **year**).

A change to **Date** takes effect immediately (rebooting is not required). However, you must reboot to make the change apparent to the operating system.

To change the date, press the right-arrow key to increase the number in the highlighted field, or press the left-arrow key to decrease the number. If you prefer, you can type numbers in the **month** and **day-of-the-month** fields.

Disk Time-out

Disk Time-out lets you determine how long your hard-disk drive remains idle before the drive motor turns off to conserve battery power.

The **AC** option is set to **Disabled**. No user-selectable settings are available for this option. Settings for the **Battery** option are:

- 1 Disabled 1 5 Minutes
- 1 15 Seconds 1 10 Minutes
- 1 1 Minute 1 15 Minutes
- 1 2 Minutes 1 30 Minutes
- 1 3 Minutes 1 1 Hour
- 1 4 Minutes

If the computer is powered by a battery, the default is **3 Minutes**. To increase battery operating time, set **Disk Time-out** to a lower number. However, if your software requires frequent hard-disk drive accesses, using a higher time-out setting may save battery power and time by minimizing the number of times the hard-disk drive must power up.

 **NOTE:** Set **Disk Time-out** to **Disabled** if using it causes compatibility problems with your software.

A change to **Disk Time-out** takes effect immediately (rebooting is not required).

If you are not in the System Setup program, you can turn off the hard-disk drive immediately by pressing <Fn><h>. The drive resumes normal operation automatically when it is accessed by the microprocessor.

Diskette Drive A

Diskette Drive A identifies the location of the 3.5-inch diskette drive: **External Media Bay**, **Parallel Port**, or **Not Installed**. No user-selectable settings are available for this option.

Diskette Drive B

Diskette Drive B identifies the location of a second 3.5-inch diskette drive: **External Media Bay**, **Parallel Port**, or **Not Installed**. No user-selectable settings are available for this option.

Diskette Reconfig

Diskette Reconfig allows hot plugging of a diskette drive and allows application programs that access the diskette drive to run at their optimum speed. Settings are **At Reboot Only** and **Any Time**.

When **Diskette Reconfig** is set to **Any Time** (the default), you do not have to reboot after you install a diskette drive in the external media bay or attach a diskette drive to the parallel connector on the back of the computer. However, when this option is set to **Any Time**, some application programs (such as virus scans) that access the diskette drive will run very slowly if no diskette drive is attached to the computer or installed in the docking option. When **Diskette Reconfig** is set to **At Reboot Only**, such application programs run at normal speed, but you must reboot after installing or attaching a diskette drive.

Display Close

Display Close lets you determine whether your computer enters suspend mode when the display is closed or whether only the display is turned off.

- 1 **Suspend** (the default) — Allows the computer to enter suspend mode when the display is closed
 - 1 **Active** — Turns off the display, but does not put the computer into suspend mode
-

Display Time-out

Display Time-out lets you decide how long the computer operates with no input/output (I/O) activity before turning off the display to conserve battery power.

Settings for this option in both **AC** and **Battery** are:

- 1 Disabled
- 1 5 Minutes
- 1 1 Minute
- 1 10 Minutes
- 1 2 Minutes
- 1 15 Minutes
- 1 3 Minutes
- 1 30 Minutes
- 1 4 Minutes
- 1 1 Hour

The default is **4 Minutes**. To increase battery operating time, set **Display Time-out** to a lower number of minutes.

 **NOTE:** Set **Display Time-out** to **Disabled** if using it causes compatibility problems with your software.

A change to **Display Time-out** takes effect immediately (rebooting is not required).

If you are not in the System Setup program, you can turn off the display immediately by pressing <Fn><d>. The display resumes normal operation automatically when you press a key, move the cursor, or press the power button.

Docking Ethernet

Docking Ethernet enables and disables the internal ethernet controller in the Dell Latitude C/Port Family Advanced Port Replicator (APR) or C/Dock Family Expansion Station. A change to this option takes effect when you reboot.

Docking IRQ

Docking IRQ tells the computer which interrupt request (IRQ) to assign to the docking station or replicator during the boot sequence. If **Docking IRQ** is set to **Optimized**, the docking station or replicator is assigned a dedicated IRQ during the boot sequence. Select **IRQ11** if a peripheral device requires the use of the dedicated IRQ.

Docking Status

Docking Status shows whether the computer is attached to a Dell Latitude C/Port Family APR or C/Dock Family Expansion Station. No user-selectable settings are available for this option.

External Hot Key

External Hot Key lets you use the <Scroll Lock> key on the external keyboard the same way you use the <Fn> key on the computer's keyboard. Set this option to **Scroll Lock** (the default) if you are using an external keyboard. Set this option to **Not Installed** to disable this function on the external keyboard.

External Media Bay

External Media Bay identifies the type of device—**Diskette Drive**, **CD-ROM Drive**, **DVD-ROM Drive**, or **LS-120 Disk Drive**—installed in the external media bay. If the external media bay does not contain a device or is not attached, this option reads **Not Installed**. No user-selectable settings are available for this option.

Infrared Data Port

Infrared Data Port is available only when the computer is docked; otherwise, this option is blue or dimmed. This option allows you to avoid resource conflicts by disabling or remapping the address of the infrared port on the Dell Latitude C/Port Family APR or C/Dock Family Expansion Station. The **COM1**, **COM2**, **COM3**, and **COM4** settings allow you to take advantage of the computer's infrared support.

Settings for this option are:

- 1 **Disabled** — Disables the infrared data port and makes the direct memory access (DMA), IRQ, and I/O resources available for another serial device to use
- 1 **COM1** — Maps the infrared data port to COM1
- 1 **COM2** — Maps the infrared data port to COM2
- 1 **COM3** (the default) — Maps the infrared data port to COM3
- 1 **COM4** — Maps the infrared data port to COM4

For a change to **Infrared Data Port** to take effect, you must reboot your computer.

Infrared Mode

Infrared Mode is visible only when the computer is docked and **Infrared Data Port** is enabled. **Infrared Mode** manages the infrared resources of the computer and the external devices you use with it. This option lets you select **Fast IR** (the default) or **Slow IR** to use with an infrared device.

For a change to **Infrared Mode** to take effect, you must reboot your computer.

Internal Cache

Internal Cache displays the amount of internal cache your computer has. No user-selectable settings are available for this option.

Keyboard Click

Keyboard Click lets you choose whether the computer's keyboard makes audible clicking sounds. **Click Volume** must be enabled for **Keyboard Click** to function. The volume of the simulated key clicks is controlled by the **Click Volume** setting.

Settings for this option are **Disabled** (the default) and **Enabled**.

A change to **Keyboard Click** takes effect immediately (rebooting is not required).

Microprocessor

Microprocessor displays the type and speed of the microprocessor installed on your computer's system board. No user-selectable settings are available for this option.

Parallel Mode

Parallel Mode controls whether the computer's integrated parallel port acts as a Personal System/2 (PS/2)-compatible (**Bidirectional**) port, Advanced Technology (AT)-compatible (**Normal**) port, or Extended Capabilities Port (**ECP**)-compatible port. The default for **Parallel Mode** is **ECP**.

The Microsoft® Windows® 95 and Windows 98 operating systems use ECP protocol automatically if it detects an ECP-compatible device.

Set this option according to the type of device connected to the parallel port. To determine the correct mode to use, see the documentation that came with the device.



*NOTE: The **ECP** setting also works for most software written for the AT and PS/2 modes. Devices that use **ECP** mode may come with special drivers that need to be installed in order to use these modes.*

Setting **Parallel Mode** to **Disabled** disables the parallel port and its assigned LPT address, freeing its interrupt for another device to use.

For a change in **Parallel Mode** to take effect, you must reboot your computer.

Pointing Device

Pointing Device enables and disables the computer's touch pad.

Settings for this option are:

- 1 **Touch Pad-PS/2 Mouse** (the default)
- 1 **Serial Mouse** — Disables the touch pad and allows you to use a mouse connected to the serial connector on the I/O port

If you want to use a serial mouse, you must first set the **Pointing Device** option to **Serial Mouse**.

For a change in **Pointing Device** to take effect, you must reboot your computer.

Power Management

Power Management (Page 4 of the System Setup screens) allows you to enable or disable power conservation features when the computer is being powered by a battery or AC power.

If you want to use any of the time-out options while using battery power, set **Battery** to **Enabled**. If you want to use the time-out options while using AC power, set **AC** to **Enabled**.

A change to **Power Management** takes effect immediately (rebooting is not required).

Primary Hard Drive

Primary Hard Drive displays the capacity of your computer's hard-disk drive. No user-selectable settings are available for this option.

Primary Password

Primary Password displays the current status of the primary password and allows you to assign or change this password.

Settings for this option are:

- 1 **Disabled** (the default) — Indicates that no primary password is assigned
- 1 **Enabled** — Indicates that a primary password is currently assigned

If you assign a primary password, the computer prompts you for the password each time you boot the computer.

NOTICE: The password features provide a high level of security for the data in your computer. However, they are not foolproof. If your data requires more security, you should obtain and use additional forms of protection, such as data encryption programs or PC Cards with encryption features.

Ring/Event Resume

Ring/Event Resume lets you determine if the computer exits suspend mode when an installed modem PC Card receives an incoming call. This feature must be supported by your modem PC Card and your operating system.

Settings for this option are:

- 1 **Enabled** (the default) — Resumes normal operation when the computer detects a modem ring
- 1 **Disabled** — Keeps the computer in suspend mode when the computer detects a modem ring



*NOTES: Dell recommends that you set **Ring/Event Resume** to **Disabled** when an external serial device, **other than a modem**, is connected to your computer.*

*For **Ring/Event Resume** to work properly, this feature must be enabled in the device driver for your modem PC Card. All drivers supplied by Dell with your computer are configured to allow the computer to resume normal operation when a modem receives an incoming call. If you use a PC Card that you did not receive from Dell, check the card's documentation to make sure that this feature is set to **Enabled**.*

A change to **Ring/Event Resume** takes effect immediately (rebooting is not required).

S2D Time-out

S2D Time-out lets you determine how long your computer remains idle (no I/O activity) before activating suspend-to-disk (S2D) mode to conserve battery power.

S2D Time-out settings for the **AC** and **Battery** options are:

- 1 Disabled
- 1 4 Hours
- 1 30 Minutes
- 1 6 Hours
- 1 1 Hour
- 1 8 Hours (default)
- 1 2 Hours
- 1 12 Hours
- 1 3 Hours

A change to **S2D Time-out** takes effect immediately (rebooting is not required).

If you are not in the System Setup program and your computer is running in Advanced Power Management (APM) mode, you can activate S2D mode at any time by pressing <Fn><a>. Press the power button to resume operation from S2D mode.

Serial Port

Serial Port allows you to disable or remap the address of the serial port on the Dell Latitude C/Port Family APR or C/Dock Family Expansion Station. When the computer is undocked, this option is blue or dimmed and has no user-selectable settings.

Settings for this option are:

- 1 **COM1** (the default) — Maps the serial port to COM1
- 1 **COM2** — Maps the serial port to COM2
- 1 **COM3** — Maps the serial port to COM3
- 1 **COM4** — Maps the serial port to COM4
- 1 **Disabled** — Disables the serial port and its assigned COM address, freeing that interrupt for another device to use

For a change to **Serial Port** to take effect, you must reboot your computer.

Service Tag

Service Tag displays the computer's alphanumeric service code, which was programmed into NVRAM by Dell during the manufacturing process. Be prepared to supply this identification during technical assistance or service calls. The service tag is also accessed by certain Dell support software, including diagnostics. No user-selectable settings are available for this option.

 **NOTE:** Convert the service tag number into an express service code when prompted to do so the first time you turn on the computer (or use the program in the **Dell Accessories** folder). Keep the code handy in case you call Dell for technical assistance. The code helps Dell's automated support telephone system direct your call more efficiently.

Smart CPU Mode

Smart CPU Mode allows the computer to slow down the microprocessor automatically if it is not being actively used.

Settings for this option are:

- 1 **Enabled** (the default) — Allows the computer to slow down the microprocessor when it is inactive
- 1 **Disabled** — Keeps the microprocessor running at its normal operating speed regardless of microprocessor inactivity

When **Smart CPU Mode** is set to **Enabled** and the microprocessor is inactive, the computer slows the microprocessor to save power.

 **NOTES:** Some communications software may not work properly when **Smart CPU Mode** is enabled. Dell recommends that you set **Smart CPU Mode** to **Disabled** if you are using communications software.

*Interactive application programs should function well when **Smart CPU Mode** is set to **Enabled**. (Examples of interactive programs include spreadsheet, text editor, graphics design, entertainment, educational, and utility programs.) If your computer runs slowly while performing such tasks as recalculating large spreadsheets, redrawing screens, or testing the microprocessor, set **Smart CPU Mode** to **Disabled**.*

A change to **Smart CPU Mode** takes effect immediately (rebooting is not required).

Suspend Time-out

Suspend Time-out lets you determine how long your computer remains idle before activating suspend mode to conserve battery power.

Suspend Time-out settings for both **AC** and **Battery** options are:

- | | |
|-------------|------------------------|
| 1 Disabled | 1 5 Minutes |
| 1 1 Minute | 1 10 Minutes (default) |
| 1 2 Minutes | 1 15 Minutes |
| 1 3 Minutes | 1 30 Minutes |
| 1 4 Minutes | 1 1 Hour |

To increase battery operating time, set **Suspend Time-out** to a lower number of minutes.

 **NOTE:** Set **Suspend Time-out** to **Disabled** if using it causes compatibility problems with your software.

A change to **Suspend Time-out** takes effect immediately (rebooting is not required).

If you are not in the System Setup program, you can activate suspend mode at any time by pressing <Fn><Esc>. The computer resumes normal operation automatically when you press the power button.

System Memory

System Memory displays the total amount of synchronous dynamic random-access memory (SDRAM) installed in your computer. No user-selectable settings are available for this option. The amount of memory displayed changes if you install or remove a memory module.

System Primary

System Primary displays the current status of the primary hard-disk drive password and allows you to assign or change this password.

Settings for this option are:

- 1 **Disabled** (the default) — Indicates that no primary hard-disk drive password is assigned
- 1 **Enabled** — Indicates that a primary hard-disk drive password is currently assigned

NOTICE: The password features provide a high level of security for the data in your computer. However, they are not foolproof. If your data requires more security, you should obtain and use additional forms of protection, such as data encryption programs or PC Cards with encryption features.

Time

Time resets the time on the computer's internal clock. Time is kept in a 24-hour format (hours:minutes:seconds).

 **NOTE:** If a network server controls the time reflected by the **Time** option, changing this option has no effect.

A change to **Time** takes effect immediately (rebooting is not required). However, you must reboot to make the change apparent to the operating system.

Universal Connect

The **Universal Connect** option functions with the Dell Latitude C/Port Family APR and/or C/Dock Family Expansion Station if the computer uses Windows 95 or Windows 98.

Set this option to **Enabled** (the default) if you often use more than one C/Port APR and/or C/Dock Expansion Station and want to minimize the initialization time when you connect an APR or expansion station to the computer. With **Universal Connect** set to **Enabled**, the system creates only one profile for each docking station family. If this option is set to **Disabled**, an APR or expansion station is reinitialized each time it is connected to the computer, and a different docking profile is created each time.

Video Memory

Video Memory displays the amount of video memory installed on the system board. No user-selectable settings are available for this option.

[Back to Contents Page](#)

Technical Specifications: Dell™ Latitude™ CS/CSx Portable Computers User's Guide

[Chip Set and Bus](#)

[PC Cards](#)

[Memory](#)

[Connectors](#)

[Audio](#)

[Video](#)

[Display](#)

[Keyboard](#)

[Battery](#)

[AC Adapter](#)

[Physical](#)

[Environmental \(Computer\)](#)

[Touch Pad](#)

Chip Set and Bus

Microprocessor	Intel® Mobile Pentium® II for the Latitude CS; Intel Mobile Pentium III for the Latitude CSx
System chip set	Intel Mobile 440 BX PCIset
Microprocessor data bus width	64 bits
DRAM bus width	64 bits
Address bus width	32 bits
Flash EPROM	4 Mbits
AGP bus	66 MHz
PCI bus	33 MHz

PC Cards

CardBus controller	Texas Instruments PCI 1225 CardBus controller
PC Card slots	two (supports type I and type II cards in any combination; type III cards can be used only in the lower slot; the upper slot supports ZV cards on computers running the Microsoft® Windows® 95 or Windows 98 operating system)
Cards supported	3.3-V and 5-V
PC Card connector size	68 pins
Data width (maximum):	
PCMCIA	16 bits
CardBus	32 bits

Memory

Architecture	SDRAM
Memory module sockets	two (one is customer-accessible for performing memory upgrades)
Memory module capacities and type	32-, 64-, 128, and 192-MB 3.3-V SDRAM ¹ modules (the 192-MB module cannot be installed in the memory upgrade socket)
Standard RAM	one 64-MB memory module
Maximum RAM	320 MB
Memory clock speed	66 MHz
Memory access time	CL2 or CL3 (Note: CL3 indicates a CAS latency of 3 clocks)
BIOS address	F000:0000-F000:FFFF

Connectors

Parallel	one unidirectional, bidirectional, or ECP connector
IDE	IDE connector for external media bay
Video	SVGA connector
PS/2	mini-DIN connector
Audio	microphone-in jack; headphones/speakers jack
USB	USB-compliant connector
Docking	connector for the C/Port Family Advanced Port Replicator or C/Dock Family Expansion Station

Audio

Audio type	Sound Blaster (software emulation-capable)
Audio controller	NeoMagic MagicMedia 256 ZX
Stereo conversion	16 bit (analog-to-digital and digital-to-analog)
Interfaces:	
Internal	PCI bus/AC97
External	microphone-in minijack; headphones/speakers-out minijack
Speaker	2.5-ohm speaker
Internal speaker amplifier	500 mW
Controls	volume can be controlled through key combinations, application program menus, or the Speaker window in the Dell Control Center (Windows 95 only)

Video

Video type	256-bit hardware-accelerated
Data bus	AGP
Video controller	NeoMagic MagicMedia 256 ZX
Video memory	4.0 MB

Display

Type	active-matrix color (TFT)
Dimensions (active area):	
Height	214.9 mm (8.46 inches)
Width	270.3 (10.64 inches)
Diagonal	337.8 mm (13.3 inches)
Maximum resolution/colors	1024 x 768 pixels; 65,536 colors
Response time (typical)	50 ms
Operating angle	0° (closed) to 180°
Viewing angles:	
Horizontal	± 40°
Vertical	+20°/-30°
Dot pitch	0.26 mm
Power consumption:	

Panel (typical)	800 mW
Backlight (medium brightness)	3.7 W
Controls	brightness can be controlled through a key combination

Keyboard

Number of keys	87 (U.S., Canada, Korea, Thailand, and locations that use traditional Chinese); 88 (Europe); 90 (Japan)
Key travel	2.7 to 2.9 mm (0.106 to 0.114 inch)
Key spacing	19.05 mm ± 0.3 mm (0.75 inch ± 0.012 inch)

Battery

Type	lithium ion
Dimensions:	
Height	16.3 mm (0.64 inch)
Depth	84.05 mm (3.31 inches)
Width	205.5 mm (8.09 inches)
Weight	0.306 kg (0.67 lb) for standard battery; 0.494 kg (1.09 lb) for high-capacity battery
Voltage	11.10 VDC for standard battery; 14.4 for optional high-capacity battery
Capacity	34 WH for standard battery; 46 WH for high-capacity battery
Charge time (approximate): ²	
Computer on	1.5 hr for standard battery; 1 hr, 50 minutes for high-capacity battery
Computer off	About 1 hour
Life span (approximate) ²	350 discharge/charge cycles
Battery life ²	From 2.5 to 3 hours for fully charged standard battery; up to 50 percent more time for fully charged high-capacity battery
Temperature range:	
Charge	0° to 35°C (32° to 95°F)
Storage	-20° to 60°C (-4° to 140°F)

AC Adapter

Input voltage	90 to 135 VAC and 164 to 264 VAC
Input current (maximum)	1.5 A
Input frequency	47 to 63 Hz
Output current	4.5 A (maximum at 4-second pulse); 3.51 A (continuous)
Rated output voltage	20.0 VDC
Height	22.94 mm (1.1 inches)
Width	58.42 mm (2.3 inches)
Depth	133.35 mm (5.25 inches)
Weight (with cables)	0.4 kg (0.9 lb)
Temperature range:	

Operating	0° to 35°C (32° to 95°F)
Storage	-20° to 60°C (-4° to 140°F)

Physical

Height	29.0 mm (1.14 inches)
Width	306.0 mm (12.05 inches)
Depth	246.0 mm (9.69 inches)
Weight	Configurations from 1.95 kg (4.3 lb) ⁴ and up

Environmental (Computer)

Temperature:	
Operating	0° to 35°C (32° to 95°F)
Storage	-20° to 60°C (-4° to 140°F)
Relative humidity (maximum):	
Operating	10% to 90% (noncondensing)
Storage	5% to 95% (noncondensing)
Maximum vibration:	
Operating	0.9 GRMS using a random-vibration spectrum that simulates truck shipment
Storage	1.3 GRMS using a random-vibration spectrum that simulates air/truck shipment
Maximum shock: ³	
Operating	152.4 cm/sec (60.0 inches/sec) (less than or equal to a pulse width of 2 ms)
Storage	203.2 cm/sec (80 inches/sec) (less than or equal to a pulse width of 2 ms)
Altitude (maximum):	
Operating	-18 to 3048 m (-59 to 10,000 ft)
Storage	-18 to 10,600 m (-59 to 35,000 ft)

Touch Pad

Interface	PS/2 (compatible with Microsoft mouse driver)
X/Y position resolution	Minimum 40 points/mm (1000 points/inch) (graphics tablet mode)
Size:	
Thickness	0.71 ± 0.15-mm (0.028 ± 0.006-inch) printed-circuit board (PCB) thickness (including mylar cover)
Width	2.50-mm (0.098-inch) PCB at highest component 83.0 ± 0.3-mm (3.268 ± .012-inch) rectangle
Height	62.5-mm (2.461-inch) maximum bezel opening 66.4 ± 0.3-mm (2.61 ± 0.012-inch) rectangle
Weight	46.5-mm (1.831-inch) maximum bezel opening 8.2 ± 0.5g (.289 ± 0.018 oz)

Power:

Supply voltage 5 V \pm 10%

Supply current 4.0 mA (nominal operating)

ESD 15 kV applied to front surface (when properly mounted)

NOTES:

¹ The Dell Latitude CS/CSx portable computer does not support some memory modules from older models of Dell portable computers, such as the Latitude CP, XP, XPI CD, or LM. It only supports SDRAM modules and does not support EDO memory modules.

² Battery performance features such as charge time and life span can vary according to the conditions under which the computer and battery are used.

³ Measured with the hard-disk drive in head-parked position.

⁴ Latitude CS system with standard battery

[Back to Contents Page](#)

[Back to Contents Page](#)

Setup and Operation: Dell™ Latitude™ CS/CSx Portable Computers User's Guide

- [AC Adapter](#)
- [Batteries](#)
- [Display](#)
- [Media Options](#)
- [Keyboard](#)
- [PC Cards](#)
- [Touch Pad](#)
- [Securing Your Computer](#)
- [Connecting External Devices](#)

[Back to Contents Page](#)

[Back to Contents Page](#)

Touch Pad: Dell™ Latitude™ CS/CSx Portable Computers User's Guide

[Using the Touch Pad](#)

[Customizing the Touch Pad](#)

Using the Touch Pad

The touch pad (see [Figure 1](#)) detects the position of your finger over a touch-sensitive area and provides the computer full mouse functionality. The touch pad's two buttons correspond to the left and right buttons on a standard mouse.

Figure 1. Touch Pad

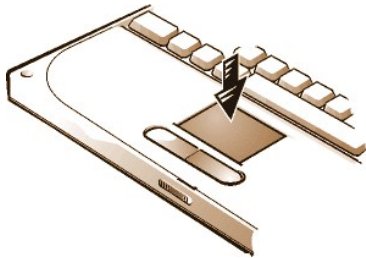

To best use the touch pad, follow these techniques:

- 1 To move the cursor, lightly slide your finger over the smooth sensor area.
- 1 To select an object, gently tap once on the surface of the touch pad.
- 1 To select and move (or drag) an object, position the cursor on the object and tap down-up-down on the touch pad. On the second down motion, leave your finger on the touch pad and move the selected object by sliding your finger across the surface.
- 1 To double-click an object, position the cursor on the object and then tap twice.

 **NOTES:** When enabled, the touch pad uses interrupt request (IRQ) 12. No other device can use IRQ12 while the touch pad is enabled.

When you attach an external PS/2 mouse to the computer, the touch pad is automatically disabled.

Customizing the Touch Pad

To customize the touch pad, perform the following steps:

1. Click the **Start** button, point to **Settings**, and click **Control Panel**.
2. Double-click the **Mouse** icon to open the **Mouse Properties** window and click the **Touch** tab.
3. Select the settings that work best for you and click **Apply**.
4. Click **OK** to save the settings and close the window.

You can also click the touch pad icon on the taskbar and click **TouchPad Properties** to open the **Mouse Properties** control panel.

[Back to Contents Page](#)

[Back to Contents Page](#)

Traveling With Your Computer: Dell™ Latitude™ CS/CSx Portable Computers User's Guide

 [Identifying Your Computer](#)

 [Preparing Your Computer for Travel](#)

 [Travel Tips](#)

Identifying Your Computer

As an antitheft measure, assign a primary password and a hard-disk drive password to prohibit unauthorized access to the computer.

Dell recommends that you follow these precautions before you travel with your computer:

- 1 Write down your [service tag](#) and put it in a safe place separate from the computer or carrying case. If the computer is lost or stolen, use the service tag number when reporting to law enforcement officials and to Dell.
- 1 Use the [Asset Tag utility](#) to place an owner tag in the computer. In the owner tag, you may want to include your name or your company's name and a contact number or electronic mail address that can be used to reach you.
- 1 Use a text editor (such as Microsoft® Windows® Notepad) to create a file called **if_found** in your root directory. Place information such as your name, address, and telephone number in this file. (For instructions on using the appropriate text editor, see the documentation that came with your operating system.)
- 1 Attach your business card or other name tag to the computer.
- 1 Contact your credit-card company and ask if it offers coded identification tags that allow your property to be returned to you without the risk of revealing your name, address, or telephone number.
- 1 Use a permanent marking or stenciling device to write your driver's license number or some other unique identifying mark on the computer. If a lost or stolen computer is recovered, such marking identifies the computer as your property.

Service Tag

The service tag is an alphanumeric sequence on a bar code label located on the bottom of the computer. The service tag is unique to your computer and allows Dell technical assistance personnel to identify the computer and its configuration quickly if you call for assistance.

If Your Computer Is Lost or Stolen

If your computer is lost or stolen, Dell suggests that you perform the following steps:

1. Call a law enforcement agency to report the lost or stolen computer.

Include the service tag in your description of the computer. Ask that a case number be assigned, and write it down. Also write down the name, address, and telephone number of the law enforcement agency. If possible, obtain the name of the investigating officer.

If you know where the computer was lost or stolen, call a law enforcement agency in that area. If you do not know, call a law enforcement agency where you live.

2. If the computer belongs to a company, notify the security office of the firm.

3. Call Dell technical assistance to report the missing computer.

Provide the computer's service tag, the case number, and the name, address, and telephone number of the law enforcement agency to which you reported the missing computer. If possible, give the name of the investigating officer.

The Dell support technician will log your report under the computer's service tag and flag the computer as missing or stolen. If someone calls Dell for technical assistance and gives your service tag, the computer is identified automatically as missing or stolen. The technician will attempt to get the phone number and address of the caller. Dell will then contact the law enforcement agency to which you made the report of the missing or stolen computer.

Preparing Your Computer for Travel

To prepare your computer for travel, perform the following steps:

1. Detach any external devices attached to the computer, and store them in a safe place. If a diskette is in the diskette drive, remove it. Remove any cables attached to installed PC Cards (you do not have to remove the PC Cards themselves).

2. To maximize battery life, check the charge on your battery. Then fully charge the battery and any spares you plan to carry with you. For more information, see "[Batteries](#)."
3. Turn off the computer or press <Fn><a> to enter suspend-to-disk mode. (On a French keyboard, press <Fn><q>.)

NOTICE: When you disconnect the AC adapter from the computer, grasp the adapter cable's connector, not the cable itself, and pull gently but firmly to avoid damaging the cable.

4. Disconnect the AC adapter.

NOTICE: When the display is closed, items left on the keyboard could damage the display.

5. Make sure that there is nothing on the keyboard and palmrest that can damage the display when you close it. Then close the display.
6. Pack all your computing accessories.

With the optional Dell carrying case, you can pack the computer and its accessories together.

 **NOTE:** Follow the travel tips and take special precautions if you are planning to travel by air.

Accessories

You may want to take some of the following accessories with you when you travel:

- 1 Spare batteries
- 1 Cables for PC Cards (such as modem and network cards)
- 1 AC adapter and AC power cable
- 1 Power adapters for foreign electrical outlets and modem cable adapters for foreign telephone networks
- 1 Appropriate printer driver files if you will be using a printer
- 1 External media bay and its cable
- 1 Diskette drive
- 1 Backup diskettes
- 1 Additional storage devices

Traveling by Air

You may want to take the following precautions when you are traveling by air with your computer:

- 1 Notify airport security in advance that you are bringing a portable computer.
- 1 Be sure to have a charged battery or the AC adapter and power cable available in case you are asked to turn on the computer.
- 1 Do not check the computer as baggage.

NOTICE: Have airport security personnel check the computer by hand. If the computer passes through a metal detector, data loss may occur. If you must pass the computer through a metal detector, first remove the hard-disk drive.

- 1 Do not put the computer through a metal detector. (The computer can safely go through an airport X-ray security machine.)
- 1 Before you use the computer on an airplane, check the in-flight magazine or ask the flight crew to verify that such use is permitted. Some airlines forbid the use of electronic devices during the flight. All airlines forbid the use of electronic devices during takeoff and landing.
- 1 Use a carrying case (available from Dell) to protect the computer and accessories during travel.
- 1 If you pack the computer in a suitcase, do not pack so tightly that the computer display breaks or so loosely that the computer slides around.
- 1 Avoid packing the computer with items such as shaving cream, colognes, perfumes, or food.
- 1 Protect the computer, the battery, and the hard-disk drive from hazards such as extreme temperatures; overexposure to sunlight; and exposure to dirt, dust, or liquids.
- 1 Pack the computer so that it does not slide around in the trunk of your car or in an overhead storage compartment.
- 1 If you are carrying a second hard-disk drive separately, protect the drive from exposure to static electricity by placing it in the case you received it in or in an antistatic bag, or wrapping it in a nonconductive fabric.

Travel Tips

- 1 Consider changing the settings of your power management options to maximize battery life if you will be using battery power for extended periods.
- 1 If you are traveling internationally, carry proof of ownership to speed your passage through customs. If the computer is provided by your employer, carry documentation of your right to use the computer. Investigate the customs regulations of the countries you plan to visit, and consider acquiring an international [carnet](#) from your government if you travel through many different countries.
- 1 Power interruptions can occur frequently in some countries. Always have a charged battery available if traveling abroad.
- 1 Credit card holders should check with their credit card companies for information about the kinds of emergency travel assistance they offer to users of portable computers. Many companies provide services that help you solve problems, such as quickly locating 3.5-inch diskettes or providing a direct-dial telephone line for your modem connection.

NOTICE: Do not use the CD-ROM, DVD-ROM, or LS-120 drive while the computer is in motion. Doing so could interrupt the flow of data to and from the CD-ROM, DVD-ROM, or LS-120 drive and the hard-disk or diskette drive.

Carnet

A carnet is an international customs document (also known as a *merchandise passport*) that facilitates temporary imports into foreign countries and is valid for up to 1 year.

[Back to Contents Page](#)

[Back to Contents Page](#)

Troubleshooting Your Computer: Dell™ Latitude™ CS/CSx Portable Computers User's Guide

 [Dell Diagnostics](#)

 [Error Messages and Flash Codes](#)

[Back to Contents Page](#)

[Back to Contents Page](#)

Installing the Microsoft® Windows® 95 and Windows 98 Operating System Drivers: Dell™ Latitude™ CS/CSx Portable Computers User's Guide

- [Overview](#)
 - [Installing Docking Drivers](#)
 - [Installing Video Drivers for Windows 95](#)
 - [Installing Video Drivers for Windows 98](#)
 - [Installing Audio Drivers](#)
 - [Installing Software Wavetable](#)
 - [Installing Touch Pad Drivers](#)
 - [Installing MS-DOS CD-ROM Drivers](#)
 - [Installing Infrared Drivers \(Windows 95 Only\)](#)
 - [Enabling Microsoft Infrared Support \(Windows 95 and Windows 98\)](#)
-

Overview

Dell provides software utilities and drivers that help you control certain features of your computer.

This section explains how to reinstall utilities and drivers on your Dell computer with the Microsoft® Windows® 95 or Windows 98 operating system.

Before proceeding, print the following procedures.

Use the program diskette set you made when you received your computer or the diskette set you received separately from Dell.

 **NOTES:** If your computer uses Windows 95 or Windows 98, the computer is already configured to work with the Dell Latitude C/Port Family Advanced Port Replicator (APR) or C/Dock Family Expansion Station.

For more information on using the operating system installed on your computer by Dell, see the operating system user's guide that came with your computer. You can also access system tools and documentation from Dell's technical support page (<http://support.dell.com>). To do so, click **Support Your Dell**, enter your [service tag](#), and click **Submit**.

NOTICE: Do not dock the computer before turning it on the first time.

Installing Docking Drivers

To install the C/Port Family APR or C/Dock Family Expansion Station drivers, perform the following steps:

1. If the computer has never been turned on, turn it on now while it is undocked and complete the operating system setup. Then go to step 2.

If you have completed the operating system setup, turn on the computer and go to step 2.

For setup instructions, see the Dell-supplied operating system *Setup Guide* that came with the computer.

2. Dock the computer.

The operating system creates a hardware profile for the C/Port APR or the C/Dock Expansion Station.
 3. To load the appropriate drivers from the CD that came with your C/Port Family APR or C/Dock Family Expansion Station, follow the instructions on the display. When prompted, restart the computer.
 4. If you intend to connect to a network, you must install the appropriate drivers to use with a network expansion card in the C/Port Family APR or C/Dock Family Expansion Station. See the documentation for your docking option for more information.
-

Installing Video Drivers for Windows 95

Video drivers control features such as screen resolution and the number of screen colors.

 **NOTE:** If you need to use extended video modes, check the documentation that came with the application program to determine if the drivers are provided. If not, contact the software manufacturer to get the necessary drivers.

To install the video drivers for Windows 95, perform the following steps:

1. Save your work in all open application programs, because you will need to restart your computer at the end of this procedure to complete the

installation.

2. Insert the video drivers diskette into the diskette drive.
3. Click the **Start** button, point to **Settings**, and then click **Control Panel**.

The **Control Panel** window appears.

4. Double-click the **Display** icon.

The **Display Properties** window appears.

5. Click the **Settings** tab.
6. Click **Advanced Properties**.

The **Advanced Display Properties** window appears.

7. Click the **Adapter** tab and then click **Change...**

The **Select Device** window appears.

8. Click **Have Disk...**
9. Verify that `a:\` is displayed in the **Install from Disk** field, and then click **OK**.
10. When the **Select Device** window appears, verify that the **NeoMagic MagicMedia 256ZX** option is highlighted, and then click **OK**.

A progress bar is shown while the driver files are copied to your hard-disk drive.

After the drivers are successfully installed, the **Advanced Display Properties** window appears.

11. In the **Advanced Display Properties** window, click **Apply** and **OK**.
12. Click **Close** in the **Display Properties** window.
13. To activate the drivers, remove the diskette from the diskette drive, and restart your computer.

After installing the video drivers and restarting your computer, set the display parameters by performing the following steps:

1. Click the **Start** button, point to **Settings**, and then click **Control Panel**.

The **Control Panel** window appears.

2. Double-click the **Display** icon.

The **Display Properties** window appears.

3. Click the **Settings** tab.
4. Change the **Color palette** option from **256 colors** to **True Color (24 bit)**.
5. Set the **Desktop** area for your display to **1024 x 768**.
6. Click **Apply**.

Installing Video Drivers for Windows 98

Video drivers control features such as screen resolution and the number of screen colors.



NOTE: If you need to use extended video modes, check the documentation that came with the application program to determine if the drivers are provided. If not, contact the software manufacturer to get the necessary drivers.

To install the video drivers for Windows 98, perform the following steps:

1. Save your work in all open application programs, because you will need to restart your computer at the end of this procedure to complete the installation.
2. Insert the video drivers diskette into the diskette drive.
3. Click the **Start** button, point to **Settings**, and then click **Control Panel**.

The **Control Panel** window appears.

4. Double-click the **Display** icon.
The **Display Properties** window appears.
5. Click the **Settings** tab and then click **Advanced....**
6. Click the **Adapter** tab and then click **Change....**
7. When the **Update Driver Wizard** appears, click **Next>**.
8. Select **Display a list of all the drivers in a specific location**, and click **Next>**.
9. When prompted for the location of the drivers, click **Have Disk....**
10. In the **Install from Disk** window, verify that a : \ is displayed in the **Install from Disk** field, and click **OK**.
The **Select Device** window appears.
11. Make sure that **NeoMagic MagicGraph 256ZX** is highlighted, and click **OK**.
12. In the **Update Device Driver Wizard** window, click **Next>** to begin copying the files, and then click **Finish**.
13. Close the **Display Properties** window.
14. When prompted to restart the computer, remove the diskette and then click **Yes**.

After installing the video drivers and restarting your computer, set the display parameters by performing the following steps:

1. Click the **Start** button, point to **Settings**, and then click **Control Panel**.
The **Control Panel** window appears.
2. Double-click the **Display** icon.
The **Display Properties** window appears.
3. Click the **Settings** tab.
4. Change the **Color palette** option from **256 colors** to **True Color (24 bit)**.
5. Set the **Desktop** area for your display to **1024 x 768**.
6. Click **Apply**.

Installing Audio Drivers

Dell provides audio drivers so that you can customize the audio features of your computer. To install the audio drivers, perform the following steps:

1. Save your work in all open application programs, because you will need to restart your computer at the end of this procedure to complete the installation.
2. Insert the audio driver diskette into the diskette drive.
3. Click the **Start** button, then click **Run....**
The **Run** dialog box appears.
4. Type a : \setup, and then click **OK** or press <Enter>.
5. Follow the instructions on your display.
6. After the files are copied to your hard-disk drive, click **Finish**.

Installing Software Wavetable

The software wavetable allows you to customize certain audio features. To install the software wavetable, perform the following steps:

1. Save your work in all open application programs, because you will need to restart your computer at the end of this procedure to complete the installation.
2. Insert the first software wavetable diskette into the diskette drive.

3. Click the **Start** button, and then click **Run....**

The **Run** dialog box appears.

4. Type `a:\setup`, and then click **OK** or press <Enter>.
 5. Follow the instructions on your display.
 6. After the installation is complete, remove the final diskette from the diskette drive and restart your computer to use the software wavetable.
-

Installing Touch Pad Drivers

Touch pad drivers and associated utilities allow you to use and customize the integrated touch pad or an external mouse. To install the touch pad drivers, perform the following steps:

1. Save your work in all open application programs, because you will need to restart your computer at the end of this procedure to complete the installation.
 2. Insert the touch-pad drivers diskette into the diskette drive.
 3. Click the **Start** button, and then click **Run....**
The **Run** dialog box appears.
 4. Type `a:\setup`, and then click **OK** or press <Enter>.
 5. Restart your computer to activate the drivers.
-

Installing MS-DOS® CD-ROM Drivers

CD-ROM drivers must be installed in order to use the MS-DOS CD-ROM utility. To install the CD-ROM drivers, perform the following steps:

1. Save your work in all open application programs, because you will need to restart your computer at the end of this procedure to complete the installation.
 2. Insert the CD-ROM drivers diskette into the diskette drive.
 3. Click the **Start** button, and then click **Run....**
The **Run** dialog box appears.
 4. Type `a:\setup`, and then click **OK** or press <Enter> to install the utility on your hard-disk drive.
 5. Follow the instructions on your display, and when prompted, restart your computer to activate the drivers.
-

Installing Infrared Drivers (Windows 95 Only)

 **NOTES:** Although your Latitude CS/CSx portable computer does not include an infrared port, the computer supports the infrared ports in the C/Port Family APR and C/Dock Family Expansion Station.

To use the infrared port, Windows 95 users must install the infrared drivers and then enable them. Windows 98 already includes the necessary drivers; Windows 98 users need only [enable](#) the infrared support.

An infrared port lets you transfer files from your computer to another infrared-compatible device without using cable connections. If your computer is running the Microsoft Windows 95 operating system, install the infrared drivers by performing the following steps:

1. Make sure that the computer is docked and that a diskette drive is connected to the computer's media bay connector or parallel port.
2. Save your work in all open application programs, because you will need to restart your computer at the end of this procedure to complete the installation.
3. Insert the infrared drivers diskette into the diskette drive.
4. Click the **Start** button, point to **Settings**, and then click **Control Panel**.
5. Double-click the **System** icon.

The **System Properties** dialog box appears.

5. Click the **Device Manager** tab.
6. Click the **View Devices by Type** radio button.
7. Click the plus sign to the left of the **Ports** icon.

The names of various device ports appear beneath the **Ports** icon.

8. Click **Infrared Serial (COM) Connections Port**, and then click **Properties**.

The **Infrared Serial (COM) Connections Port Properties** dialog box appears.

9. Click the **Driver** tab and then click **Update Driver...**

The **Update Device Driver Wizard** appears.

10. Click the **Yes (Recommended)** radio button, and then click **Next**.

Windows 95 searches for the drivers on the diskette you inserted in step 3.

11. To update the driver, follow the instructions on your display.

12. After the driver is updated, close the **Device Manager** and open **Windows Explorer**.

13. With the *Infrared Drivers* diskette still in the diskette drive, click **drive A**.

14. Right-click the **smcirlap.inf** file.

A pop-up menu appears.

15. Click **Install**.

The **smcirlap.inf** file is installed.

16. Restart your computer, and perform the procedure for [enabling](#) the infrared support.

Enabling Microsoft Infrared Support (Windows 95 and Windows 98)

 **NOTE:** Your Latitude CS/CSx portable computer supports the infrared ports in the C/Port Family APR and C/Dock Family Expansion Station. The computer itself not include an infrared port.

For Windows 95, you must [install](#) the infrared drivers before you can enable them (Windows 98 already includes infrared support). For both Windows 95 and Windows 98, you must enable Microsoft infrared support before you can use it. To enable Microsoft infrared support, perform the following steps:

1. Click the **Start** button, point to **Settings**, and then click **Control Panel**.
2. Double-click the **Add New Hardware** icon.
The **Add New Hardware Wizard** appears.
3. Click **Next** to continue.
4. When the **Add New Hardware Wizard** asks to search for new hardware, click **No** and then click **Next**.
5. When the **Hardware Types** window appears, click **Infrared** and then click **Next**.
6. When the **Add Infrared Device Wizard** window appears, click **Next**.
7. (Windows 95 only) When the **Manufacturers and Models** window appears, select **Standard Infrared Devices** from the **Manufacturers** list and **Built-In Infrared Port on Laptop or Desktop** from the **Models** list, and then click **Next**.
8. Follow the instructions on your display.
9. To enable infrared support, shut down and reboot your computer.

[Back to Contents Page](#)

[Back to Contents Page](#)

Installing the Microsoft® Windows NT® Operating System Drivers: Dell™ Latitude™ CS/CSx Portable Computers User's Guide

- [Overview](#)
 - [Installing Video Drivers](#)
 - [Installing the Power Management Utility](#)
 - [Installing Softex Docking Services](#)
 - [Installing the PC Card Utility](#)
 - [Installing Audio Drivers](#)
 - [Installing Touch Pad Drivers](#)
 - [Installing System Utilities](#)
 - [Installing the Software Wavetable](#)
-

Overview

Dell provides software utilities and drivers that help you control certain features of your computer.

This section explains how to reinstall utilities and drivers on your Dell computer with the Microsoft® Windows NT® 4.0 operating system.

 **NOTE:** You may need administrator privileges to perform some of the procedures in this section. Dell recommends that you check with your network administrator before performing the procedures.

For more information on using the operating system installed on your computer by Dell, see the operating system user's guide that came with your computer.

Use the program diskette set you made when you received your computer or the diskette set you received separately from Dell. You can also access system tools and documentation from Dell's technical support page (<http://support.dell.com>). To do so, click **Support Your Dell**, enter your [service tag](#), and click **Submit**.

Installing Video Drivers

Video drivers control features such as screen resolution and the number of screen colors.

 **NOTE:** If you need to use extended video modes, check the documentation that came with the application program to determine if the drivers are provided. If not, contact the software manufacturer to get the necessary drivers.

To install the video drivers for Windows NT 4.0, perform the following steps:

1. Save your work in all open application programs, because you will need to restart your computer at the end of this procedure to complete the installation.
2. Insert the video drivers diskette into the diskette drive.
3. Click the **Start** button, point to **Settings**, and then click **Control Panel**.
The **Control Panel** window appears.
4. Double-click the **Display** icon.
The **Display Properties** window appears.
5. Click the **Settings** tab.
6. Click **Display Type....**
The **Display Type** window appears.
7. In the **Adapter Type** box, click **Change....**
8. The **Change Display** window appears.
9. Click **Have Disk....**
10. Verify that a : \ is displayed in the **Install from Disk** box, and then click **OK**.

11. When the **Change Display** window appears, verify that the **NeoMagic MagicMedia 256ZX** option is highlighted, and then click **OK**.

A progress bar is shown while the driver files are copied to your hard-disk drive.

After the drivers are successfully installed, the **Installing Driver** window appears.

12. Click **OK** in the **Installing Driver** window.
13. Click **Close** in the **Display Type** window, and then click **Close** in the **Display Properties** window.
14. To activate the drivers, remove the diskette from the diskette drive, and restart your computer.

Installing the Power Management Utility

Dell provides a power management utility that helps you conserve battery power and view available power levels. To install the power management utility, perform the following steps:

1. Save your work in all open application programs, because you will need to restart your computer at the end of this procedure to complete the installation.

2. Insert the Softex power management utility diskette into the diskette drive.

3. Click the **Start** button, and then click **Run...**

The **Run** dialog box appears.

4. Type `a:\setup`, and then click **OK** or press <Enter>.

Follow the instructions on the display.

5. When prompted, restart your computer to activate the utility.

Installing Softex Docking Services

Dell provides Softex Docking Services software that contains support for the following features:

- 1 Hot-docking and warm-undocking a Latitude CS/CSx portable computer from supported docking stations
- 1 Hot-swapping devices such as diskette, hard-disk, large-storage, DVD-ROM, and CD-ROM drives to and from your portable computer's external media bay and the C/Dock Family Expansion Station's media bay
- 1 Compatibility with the Power Management Controller, which allows you to suspend and resume your portable computer without affecting your ability to use the docking station or its media bay
- 1 Docking or undocking your portable computer while it is in suspend mode
- 1 Docking services available in French, German, Italian, Spanish, and Japanese

For information about installing Softex Docking Services, see the Softex Docking Services user's guides at <http://www.dell.com/products/notebook/latitude/NT40.htm> and see your *Dell-Installed Microsoft Windows NT Workstation Setup Guide*.

Installing the PC Card Utility

Dell provides a PC Card utility that allows you to view and configure settings for your PC Card(s). To install the PC Card utility, perform the following steps:

1. Save your work in all open application programs, because you will need to restart your computer at the end of this procedure to complete the installation.

2. Insert the first Softex PC Card controller diskette into the diskette drive.

3. Click the **Start** button, and then click **Run...**

The **Run** dialog box appears.

4. Type `a:\setup`, and then click **OK** or press <Enter>.

Follow the instructions on your display.

5. Restart your computer.

6. When the computer completes the starting sequence, the **Softex PC Card Controller Diagnostics** window appears.
 7. Follow the instructions on your display, and when prompted, restart your computer to activate the utility.
-

Installing Audio Drivers

To install the audio drivers, perform the following steps:

1. Save your work in all open application programs, because you will need to restart your computer at the end of this procedure to complete the installation.
2. Insert the audio driver diskette into the diskette drive.
3. Click the **Start** button, point to **Settings**, and then click **Control Panel**.
4. Double-click the **Multimedia** icon.

The **Multimedia Properties** dialog box appears.

5. Click the **Devices** tab.
6. Click **Add...**

The **Add** dialog box appears, displaying a list of drivers.

7. Click the **Unlisted or Updated Driver** option, and then click **OK**.

The **Install Driver** dialog box appears.

8. Verify that **A:** is highlighted, and then click **OK**.

The **Add Unlisted or Updated Driver** window appears.

9. Verify that **NeoMagic MagicMedia 256** is highlighted, and then click **OK**.

The **Audio** dialog box appears.

10. Click **OK**.
 11. After installation is completed, restart your computer to activate the drivers.
-

Installing Touch Pad Drivers

Touch pad drivers and associated utilities allow you to use and customize the integrated touch pad or an external mouse. To install the touch pad drivers, perform the following steps:

1. Save your work in all open application programs, because you will need to restart your computer at the end of this procedure to complete the installation.
2. Insert the touch-pad drivers diskette into the diskette drive.
3. Click the **Start** button, and then click **Run...**

The **Run** dialog box appears.

4. Type `a:\setup`, and then click **OK** or press <Enter>.

Follow the instructions on your display.

5. When prompted, restart the computer to activate the drivers.
-

Installing System Utilities

System utilities let you configure features such as the [asset tag](#) code and [suspend-to-disk](#) partition. To copy the system utilities to your hard-disk drive, perform the following steps.

 **NOTE:** You can also run the system utilities directly from the System Utilities diskette.

1. Insert the *System Utilities* diskette into the diskette drive.
2. Copy each of the utilities on the *System Utilities* diskette to the **c:\dell** directory on your hard-disk drive. The utilities have the following filenames: **mks2d.exe**, **rms2d.exe**, **asset.com**, and **readme.s2d**.

For more information on copying files, see the documentation that came with the operating system.

After you copy the utilities to your hard-disk drive, you must restart your computer in the MS-DOS® mode to use the utilities.

Installing the Software Wavetable

The software wavetable allows you to customize certain audio features. To install the software wavetable, perform the following steps:

1. Save your work in all open application programs, because you will need to restart your computer at the end of this procedure to complete the installation.
2. Insert the first software wavetable diskette into the diskette drive.
3. Click the **Start** button, and then click **Run...**

The **Run** dialog box appears.

4. Type `a:\setup`, and then click **OK** or press <Enter>.

Follow the instructions on your display.

5. After the installation is complete, remove the final diskette from the diskette drive and restart your computer to use the software wavetable.
-

[Back to Contents Page](#)